



RUTLAND COUNTY
GARDEN FURNITURE

Hand-Crafted

ASSEMBLY INSTRUCTIONS

THE WALL MOUNTED BOX PERGOLA & DECKING KIT

Before you commence the assembly process we recommend that you read these instructions thoroughly beforehand to familiarise yourself with the assembly process and to also check that you have the correct components. If for any reason you need assistance, you can find our contact details on the final page of these instructions.

We highly recommend that any assembly is carried out on an open flat, level surface if possible with sufficient space. You will also require the assistance of at least 2 adults to complete assembly safely.







Please note: You can remove up to 400mm from the bottom of each post prior to commencing construction.



THE WALL MOUNTED BOX PERGOLA & DECKING KIT

THE WALL MOUNTED BOX PERGOLA & DECKING KIT

Component List

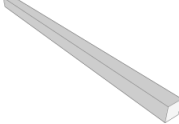
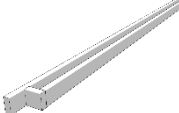
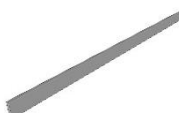
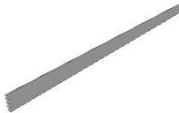
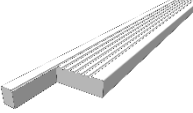
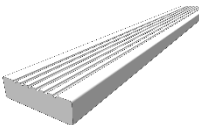
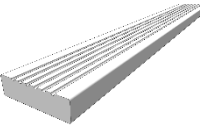
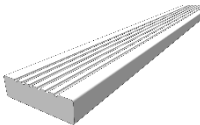
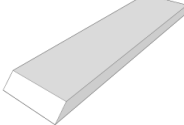
Tools required:		10mm socket, No2 Pozidriv screwdriver (or electric driver) , step ladder or platform.			
75mm x Woodscrews	65mm x Woodscrews	70mm coachscrews	120mm coachscrews	Outer Rafters	Rafters
					
Wallplate/ Runner	2 x Posts	Base frame	2 x Edge joists (with pencil marks)	5 x cross joists	2 x Post deck slats
					
Deck slats	2 x Upstand deck side slats	1 x Upstand deck front slat	16 x Cladding panels (optional)		
					

If you have ordered your pergola with a roof slope please refer to the charts below for guidance of the difference in length that you will need to cut your posts to accommodate the slope.

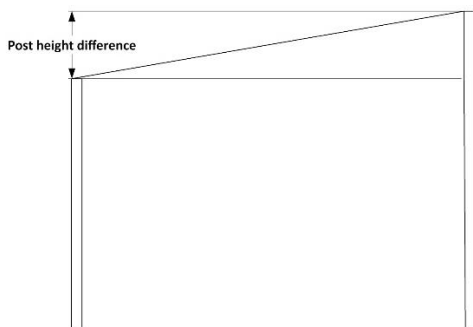

5°	
Rafter length (M)	Post height difference (mm)
1.8	143
2.4	195
3	247
3.6	300
4.2	352
4.8	404

10°	
Rafter length (M)	Post height difference (mm)
1.8	284
2.4	388
3	493
3.6	597
4.2	701
4.8	805

THE WALL MOUNTED BOX PERGOLA & DECKING KIT

Step 1

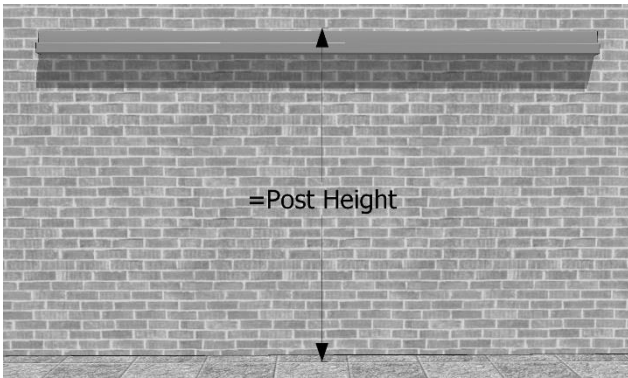

Affix your wallplate (no countersinks, batten at the bottom) in the desired location, making sure that the area directly in front of it is flat, level and able to support the structure. Attach the wall plate using suitable fixings for the wall construction. Measure in 400mm from each end and use sufficient fixings so that the minimum distance between them is 500mm, distributed evenly and vertically centred across the wall. Ensure it is horizontal with a laser or spirit level.

Step 2

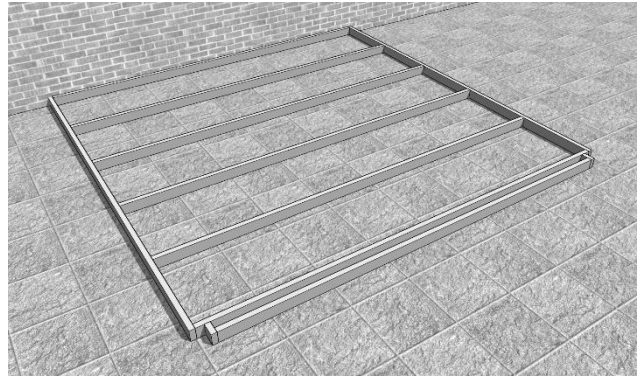

Layout the Base frame assembly and 2 x Edge joists (pencil marks on top) in a rectangle and then place the remaining cross joists roughly in place as shown here.

Step 3

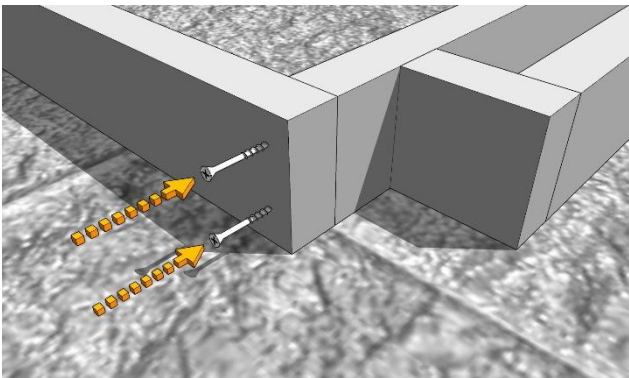

Attach the edge joists to the base frame assemblies using 2 x 75mm screws in the pre-drilled holes, making sure that the ends are flush and everything is square.

Step 4

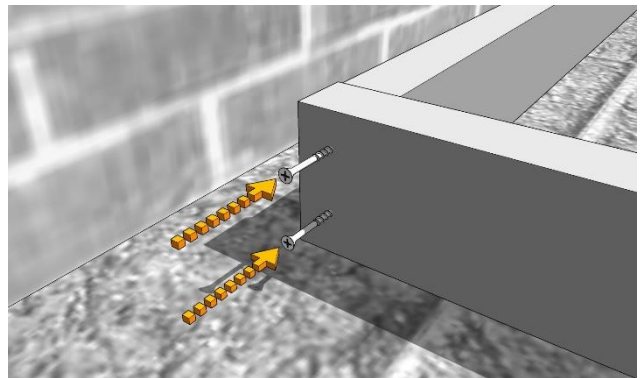

Butt the end of the joist closest to the wall up to the end of the side frame, make sure everything is flush and aligned and then screw through the pre-drilled holes in the side frame into the joist end using 2 x 75 woodscrews. Repeat for the other side.

THE WALL MOUNTED BOX PERGOLA & DECKING KIT

Step 5

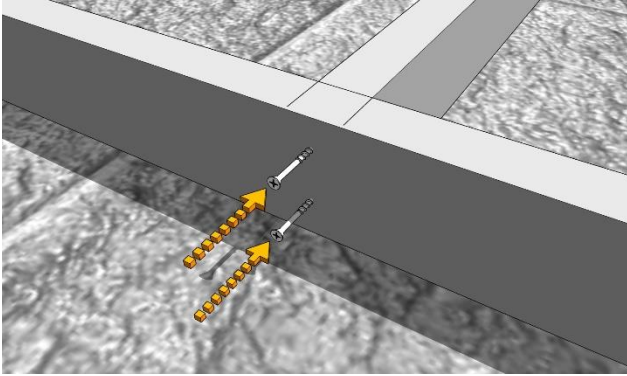

Line up the ends of each infill joist end with the markings on the edge joists, making sure the top faces are also flush, before screwing each end into place with 2 x 75mm woodscrews. Add the remaining joists to complete the frame for the decking.

Step 6

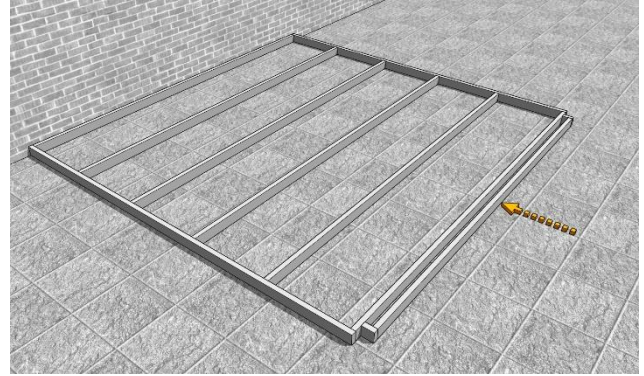

With the base assembly complete, slide it into place against the wall. To ensure it is central on the wall plate, mark the centre of the wall plate and the base and drop a plumb line from the wall plate - adjust the base position until the line and centre mark coincide.

Step 7

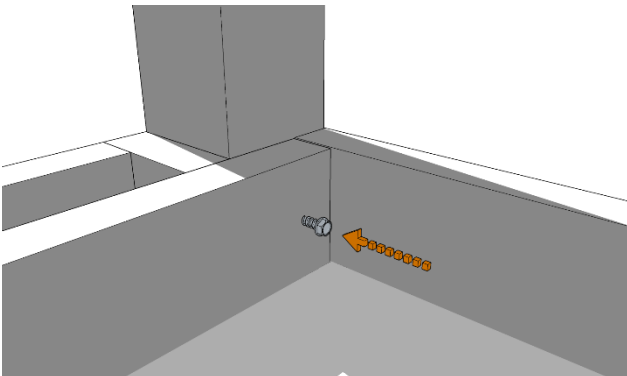

Get an assistant to hold the first post in place, housing it in the pocket formed where the base frame assembly and edge pieces meet.

Step 8

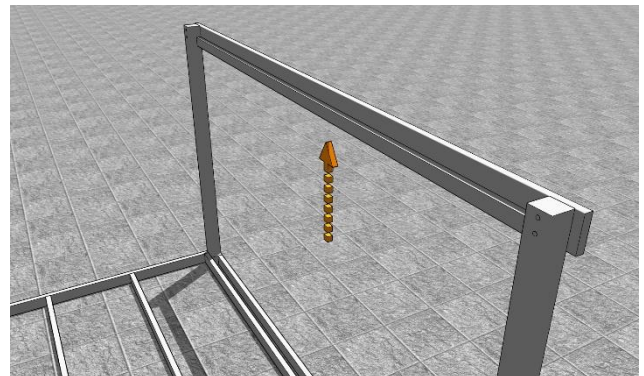

Have an assistant (or even two) help you lift one of the runners, batten at the lower edge and facing the wall, countersinks facing outwards into place against the post tops.

THE WALL MOUNTED BOX PERGOLA & DECKING KIT

Step 9

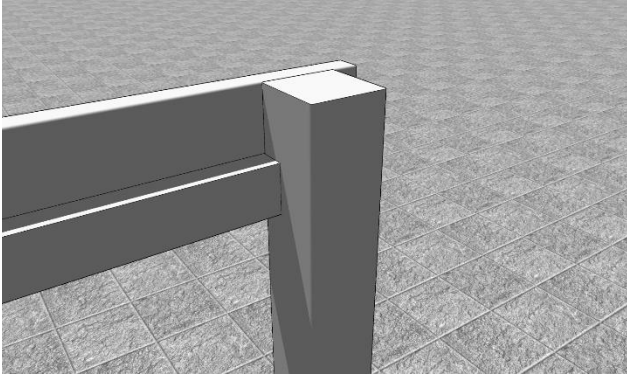

Ensure the runner is snug against the post and the top edge is flush with the top of the post.

Step 10

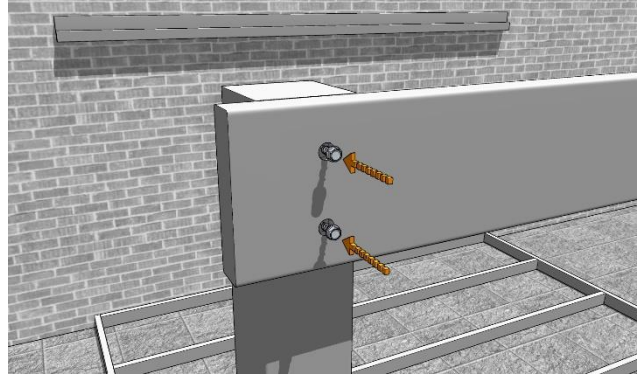

Now fix into place with 2 x 70mm coachscrews driven through the countersinks into the post.

Step 11

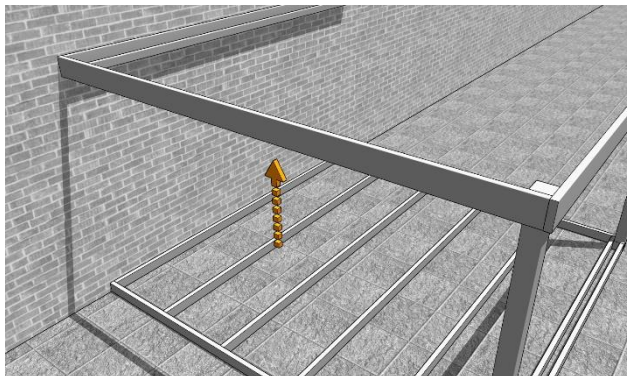

Align one of the outer rafters between the wallplate and the post as shown here.

Step 12

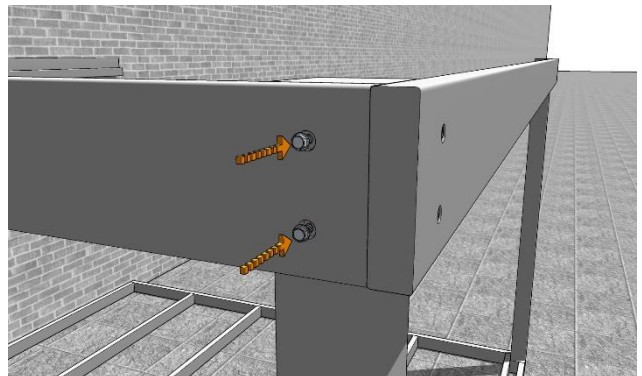

Ensure the top of the rafter is level with the top of the post before securing into the post with 2 x 70mm coachscrews.

THE WALL MOUNTED BOX PERGOLA & DECKING KIT

Step 13

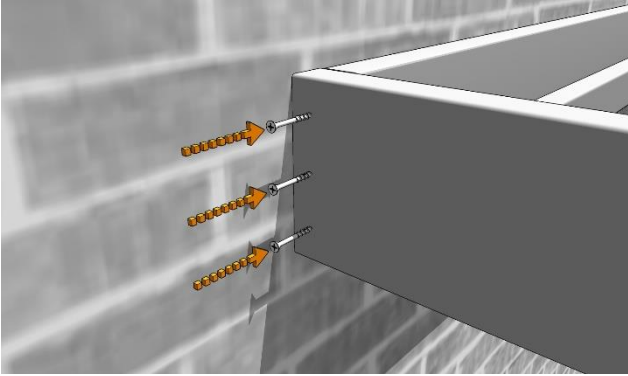

Now secure the other end of the rafter to the wallplate with 3 x 75mm woodscrews. Fix the other outer rafter in place, repeating Steps 11 to 13.

Step 14

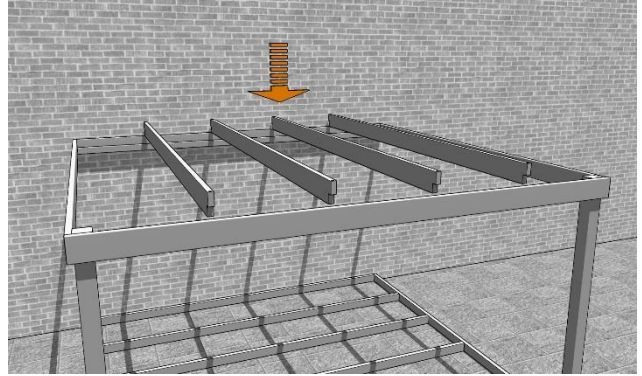

Now fix the rafters into place by lining them up with the marks on the runner and wallplate....

Step 15

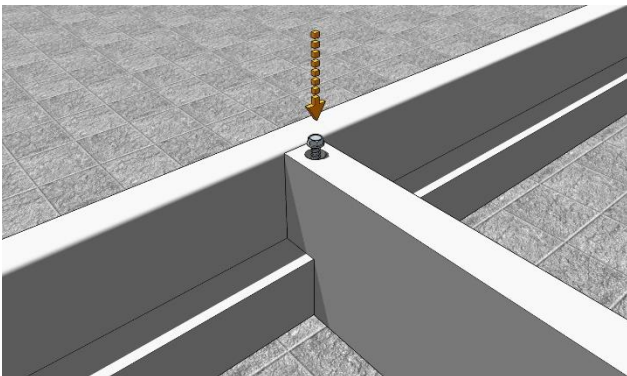

...before securing each one in place with a 120mm coachscrew into the runner batten...

Step 16

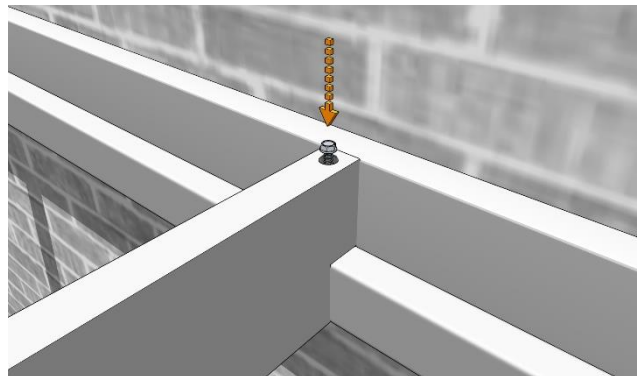

...and another into the wallplate batten.

THE WALL MOUNTED BOX PERGOLA & DECKING KIT

Step 15

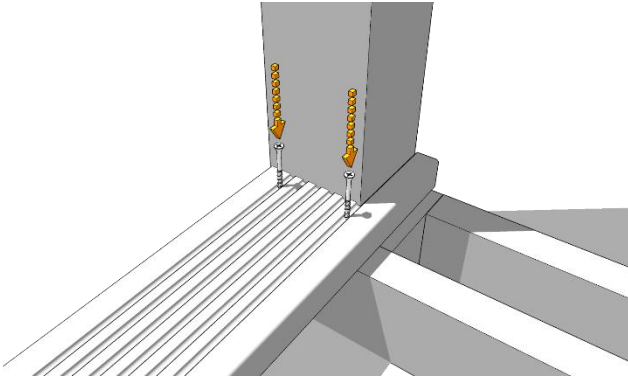

Place one of the Post deck slats so that it runs post to wall, perpendicular to the cross joists. Make sure the edge is flush with the outer edge of the frame before securing each end in place with 2 x 65mm woodscrews.

Step 16

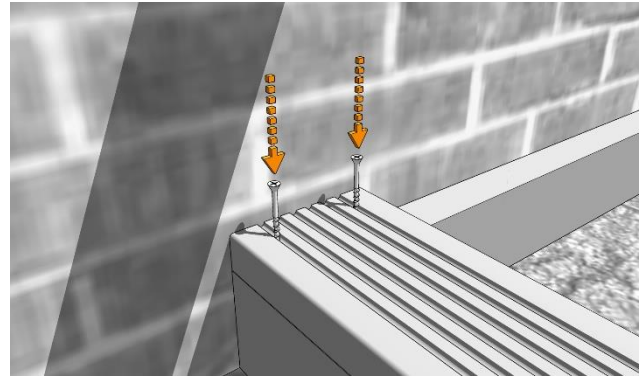

Align the rear facing end of the same section in place, again aligning its outer edge with that of the frame section before securing in place with 2 x 65mm woodscrews.

Step 17

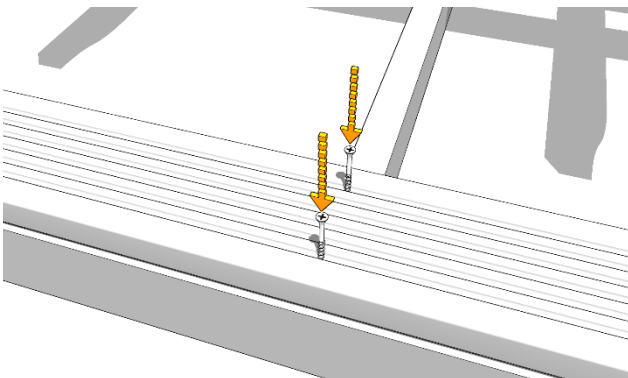

Find the most central joist and, having checked the edge of the deck slat is flush with the frame edge (push/pull the slat into place if required) secure in place with 2 x 65mm woodscrews into the joist. Attach the second Post deck slat to the opposite side of the base in the same way.

Step 18

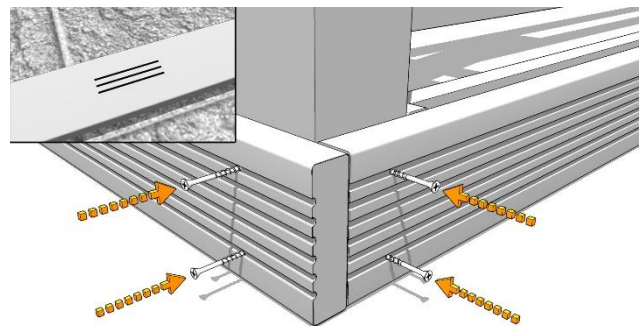

Now arrange the upstand edge decking pieces (marked on the reverse as shown in the inset pictured) around the perimeter of the frame with the front upstand deck piece parallel to the base frame. Fix the end of each piece into place at each post with 2 x 65mm woodscrews as shown here.

THE WALL MOUNTED BOX PERGOLA & DECKING KIT

Step 19

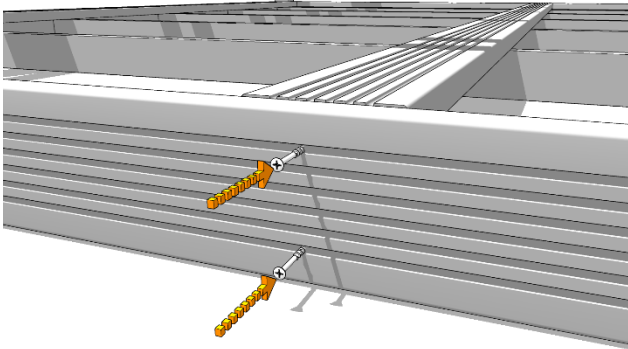

Lay one of the deck slats across the base, perpendicular to the joists. Make sure this slat is sitting on the base framework correctly and use this as a guide to ensure the centre of the front upstand piece is flush with deck. Push/pull the upstand up or down if necessary, before fixing it into place with 2 x 65mm woodscrews.

Step 20

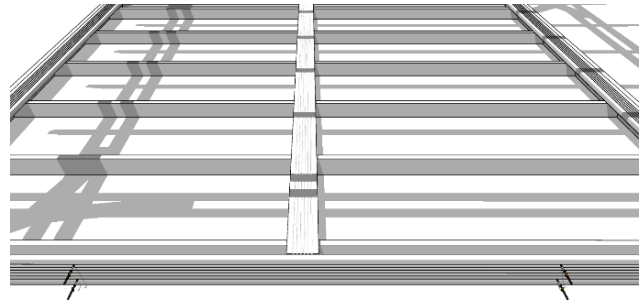

Halfway between the post and the frame centre add further intermediate screws to finish securing the upstand edge slats in place. Attach the remaining upstand edge slats to the sides.

Step 21

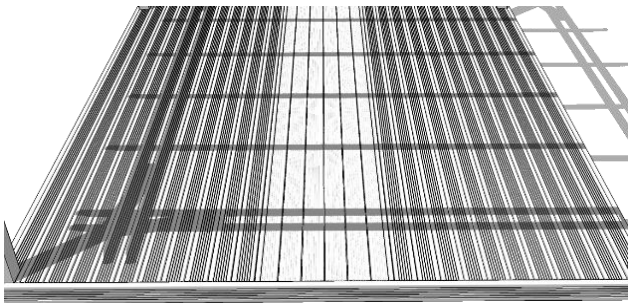

Lay out all of the decking pieces across the cross joists and adjust until you have them evenly spaced across the base.

Step 22

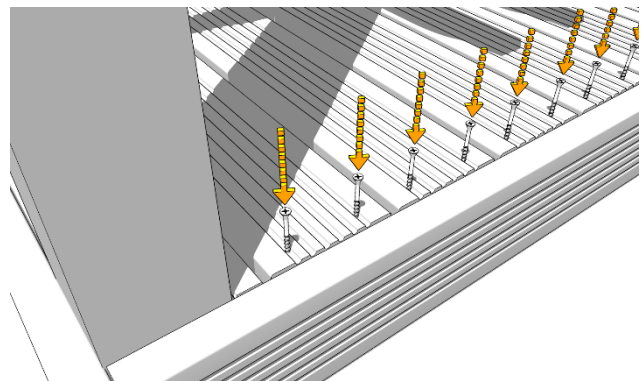

Fix both ends of every slat down with 2 x 65mm woodscrews.

THE WALL MOUNTED BOX PERGOLA & DECKING KIT

Step 23

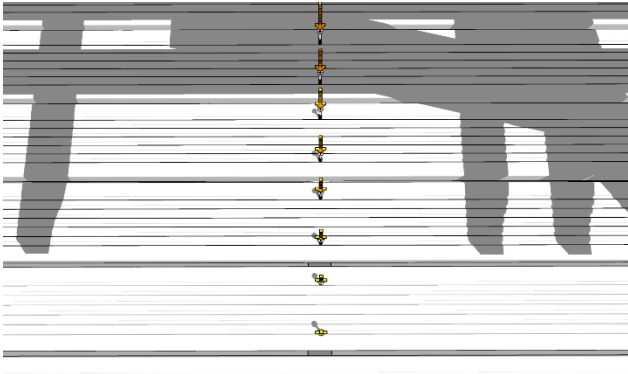

Locate each of the infill joists by looking through the gaps in between the slats and secure every decking slat to each infill joist with a pair of 65mm woodscrews.

Optional

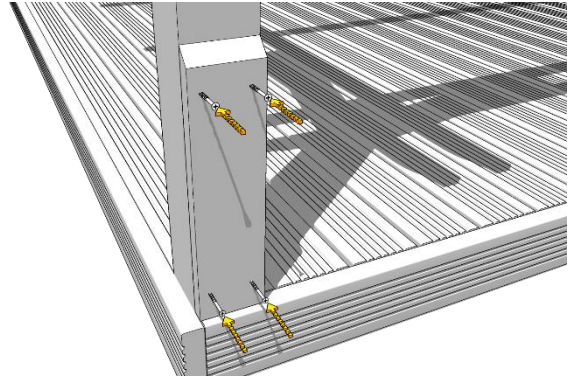

Attach four cladding panels to each post face by aligning with the post, bevelled face uppermost, and secure in place with 4 x 65mm woodscrews.

Step 23

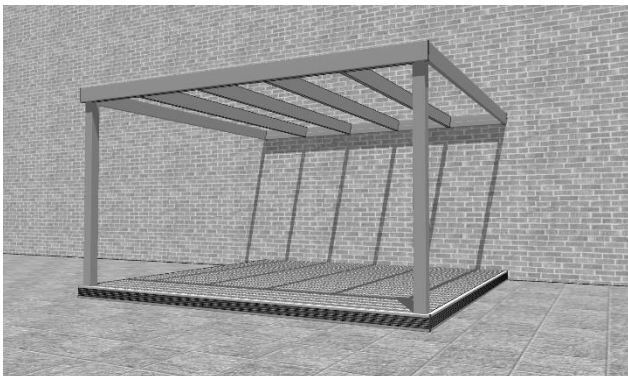

Your Rutland Wall Mounted Box Pergola & Decking Kit is now complete.

WE HOPE THAT YOU FOUND YOUR PRODUCT QUICK AND EASY TO ASSEMBLE BUT IF NOT AND YOU REQUIRE ANY FURTHER ASSISTANCE OR HAVE ANY QUESTIONS YOU CAN CONTACT US BY TELEPHONE ON: 01778 440803

EMAIL: INFO@RUTLANDCOUNTYGARDENFURNITURE.CO.UK

WWW.RUTLANDCOUNTYGARDENFURNITURE.CO.UK

Rutland County Garden Furniture Ltd, Ashbourne House, 2 Dovecote Meadows,
Aslackby, Sleaford, Lincs, NG34 0HZ.
Company No: 11025348 VAT No: 282569762