



RUTLAND COUNTY  
GARDEN FURNITURE

*Hand-Crafted*

# ASSEMBLY INSTRUCTIONS

## RUTLAND PORCH – 1.8M

Before you commence the assembly process, we strongly recommend that you read these instructions thoroughly beforehand to familiarise yourself with the assembly process and to also check that you have the correct components. If for any reason you need assistance or you believe anything is missing, you can find our contact details on the final page of these instructions.

As with all DIY projects ensure that all necessary health and safety precautions are taken such as, but not limited to, the wearing of gloves, goggles, masks and appropriate footwear – particularly if you intend to use power tools. For safety reasons, you will also need a stable platform or scaffold tower to complete this project.

If for any reason you don't feel confident in completing this project, we would recommend consulting a qualified professional to undertake the work.

### **Tools required:**

No2 Pozidriv screwdriver (or electric driver), Measuring tape, Scissors or craft knife, Hammer, Spirit level or Laser, Craft knife, 10mm socket or drive bit, pencil or chalk.





THE RUTLAND PORCH RANGE

# RUTLAND PORCH RANGE

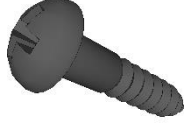
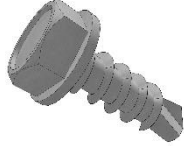
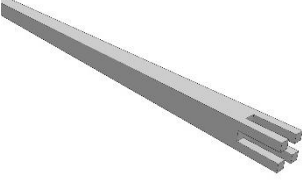
## Component List

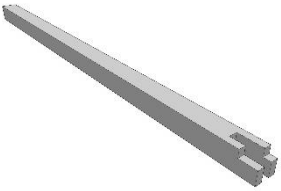
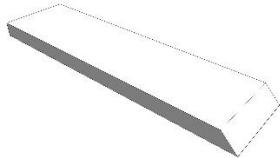
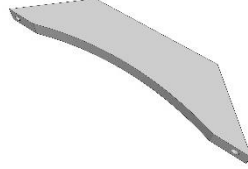
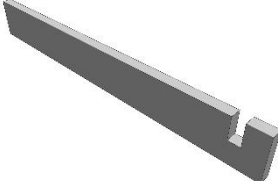
Woodscrews – 20, 40, 60 & 90mm	Dome head screws	Coach screws – 50, 70, 120 & 200mm	Front posts
			

Rear posts (L & R – 4 post version only)	Cladding panels	Braces	Side runners
			

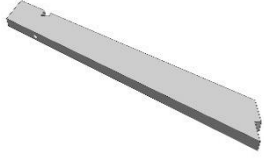
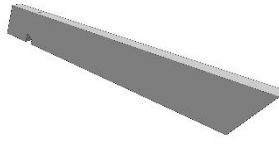
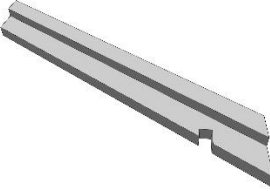
Front runner	Wall rafters	Intermediate rafters	Front rafter assemblies
			



 Slate roof version only

 Felt roof version only

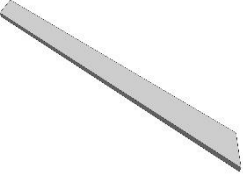
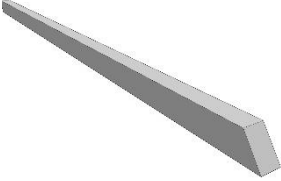
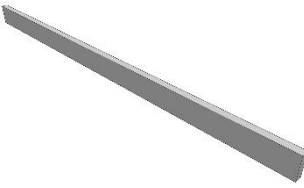
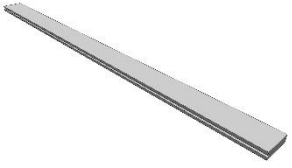
# RUTLAND PORCH RANGE

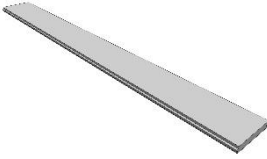
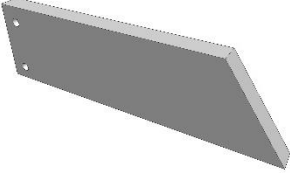
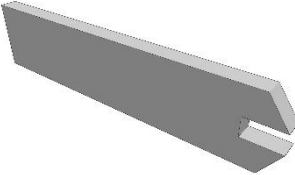
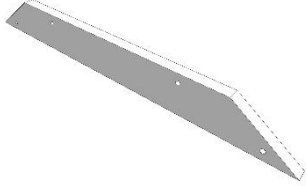
Fascia panels	Fascia trim	Side trims	Ridge roof slat
			

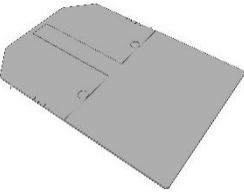
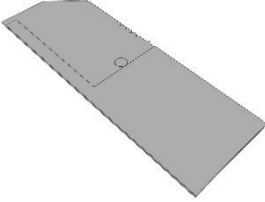
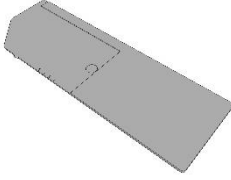
Roof slats	Fan strut	King post	Collar beam
			

Roof slate	Roof slate (left)	Roof slate (right)	Half roof slate
			

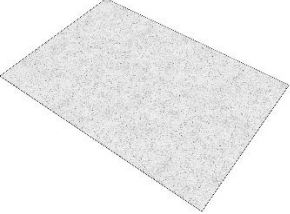
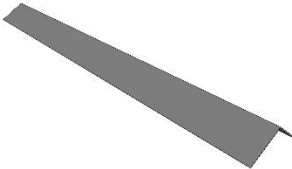
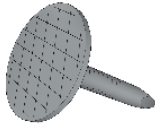
Felt and sealant	Underlay	Capping	Clout nails
			

Rutland County Garden Furniture Ltd, Ashbourne House, 2 Dovecote Meadows,  
 Aslackby, Sleaford, Lincs, NG34 0HZ.  
 Company No: 11025348 VAT No: 282569762

# RUTLAND PORCH RANGE

## Preparation

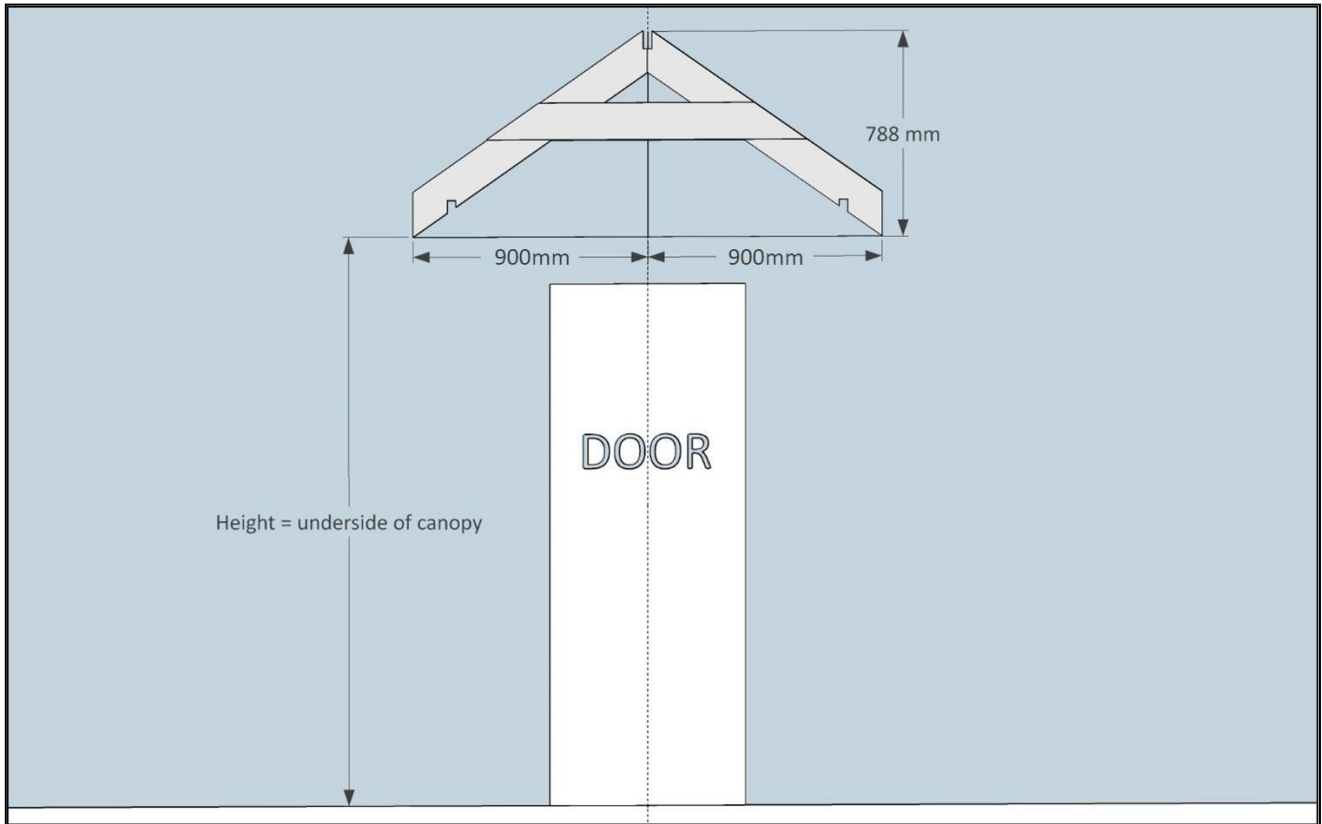

## Preparation

Before commencing assembly take some time to visualise where your porch will be located, noting any potential obstacles such as external downpipes, guttering, cabling, fixtures etc that will affect the placement of your wall rafters. It is usual to place the porch over the centre of the door and with sufficient clearance under the canopy so as not to be a hazard – a height of at least 2M to the underside of the front runner is generally recommended.

Study the drawing above as a reference before marking out the wall. Decide the height of your canopy and use a non-permanent marker (pencil or chalk are ideal) to mark two horizontal lines on the wall approximately 900mm either side of the centre point of the door and one directly above the door itself, all at the height of your canopy underside. Now start a vertical line based on the centre point and starting 788mm above the centre horizontal line and drawn down the wall, 150mm or so in length so you can centre the apex of the rafters.

# RUTLAND PORCH RANGE

## Build Step 1

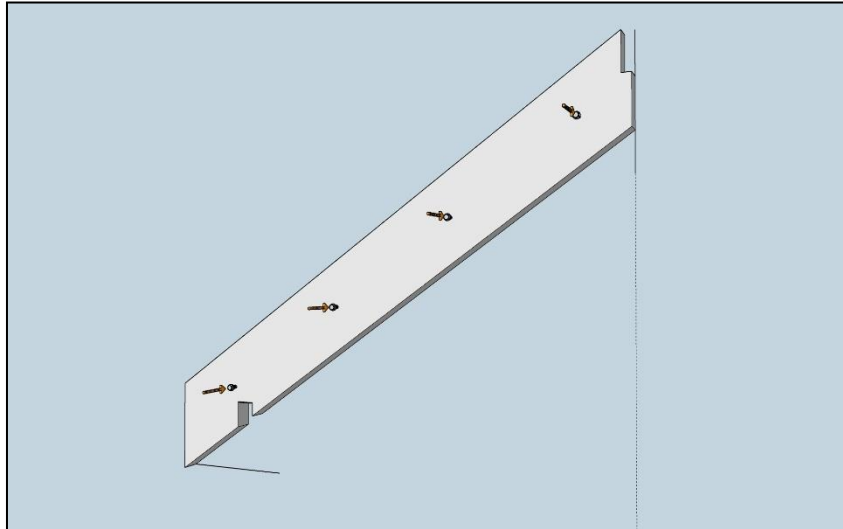

Using your previously marked out lines, position one of the Wall rafters as shown, with the bottom tip of the rafter on the horizontal line and the face of the higher end on the vertical line as shown. Generally we would recommend hammer/frame fixings after drilling suitable holes but the actual fixing method will vary depending on the wall construction. Please seek advice if you are unsure of the best method.

## Build Step 2

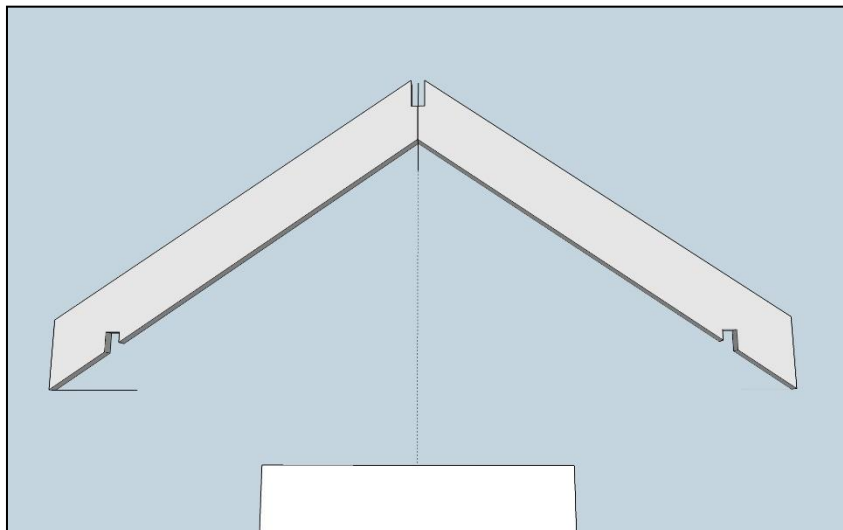

Now align the second wall rafter to the first one, using the lines where necessary and fix in place.

# RUTLAND PORCH RANGE

## Build Step 3

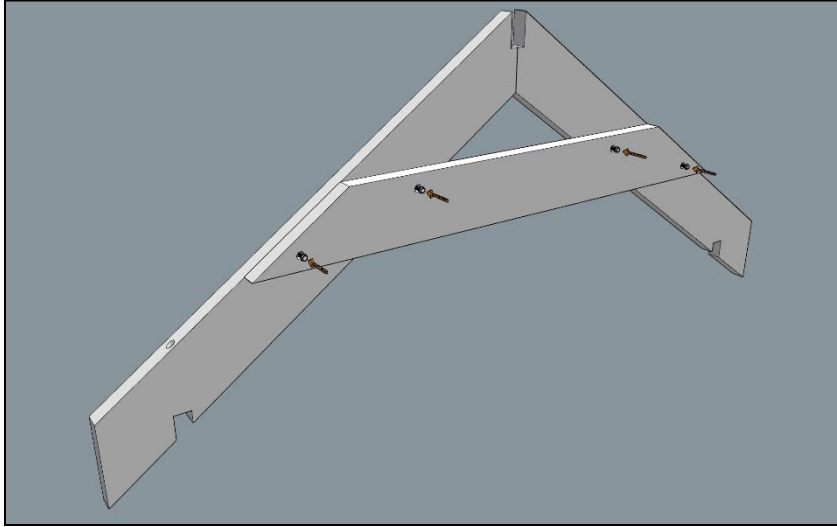

Now centre the collar beam horizontally across the wall rafters so that each end is flush with the top edge of the wall rafters and fix into place with 4 x 50mm coach screws through the pre-drilled countersunk holes.

## Build Step 4

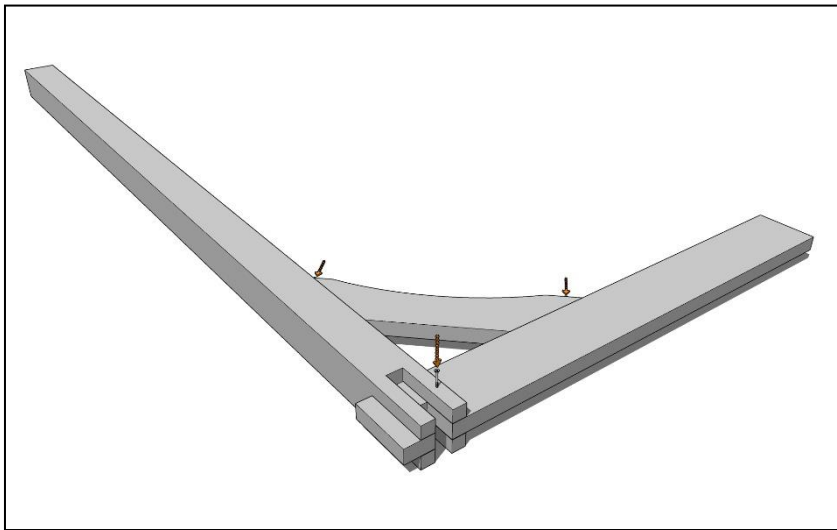

Add 140mm to your canopy height (horizontal line on wall) and trim your front posts to this length. Remember to take into account any ground rise or fall where the posts will finally sit and **DO NOT** remove the notched end! Now take one of the trimmed front posts and a side runner and use a 60mm screw to fix the side runner into the post slot. Ensure the side runner is fully seated in the slot and the slots in both the runner and post align properly before fixing. Now add a brace to reinforce the joint using 2 x 70mm coach screws to secure it in place against the post and the underside of the runner. Repeat this process so you have 2 x identical assemblies.

# RUTLAND PORCH RANGE

## Build Step 5

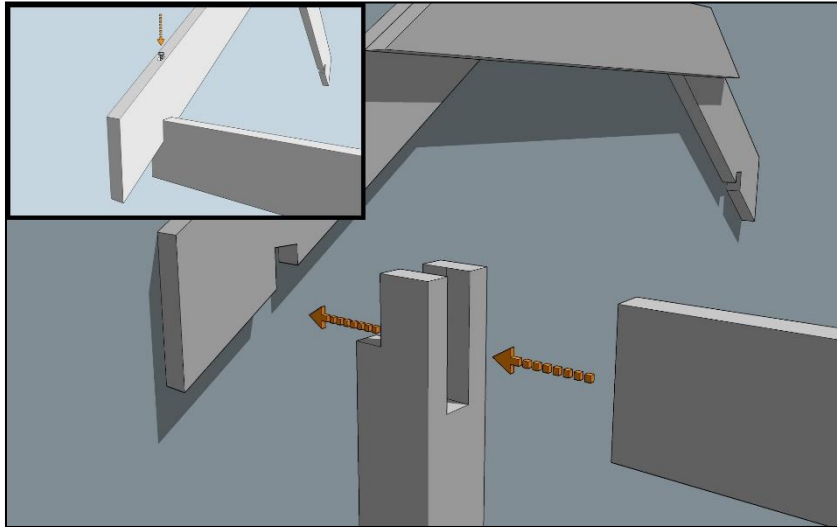

Take one of the assemblies from the previous stage and a rear post (4 post version only). Ensure you have the correct post by offering it up to the slot on the wall rafter first. Now slide the assembly through the post and into the notch under the wall rafter and push the post flush against the wall (2 post version – simply slot the assembly into the notch). TIP: if the ground in front of the porch is uneven it may be necessary to adjust you post height(s) to accommodate this.

## Build Step 6

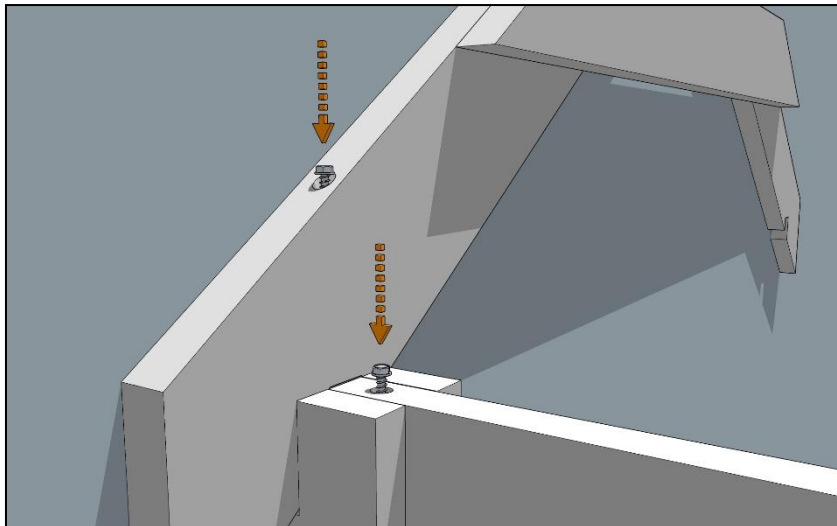

Now drive a 200mm coach screw down into the countersunk hole in the top of the wall rafter and into the top of the side runner, then a second 200mm coach screw down through the countersink in the rafter into the post for a 4-post version. Repeat this process for the remaining assembly and rear post on the other wall rafter. At this point you may optionally fix the bottom of the rear posts to the wall using suitable fixings.

# RUTLAND PORCH RANGE

## Build Step 7

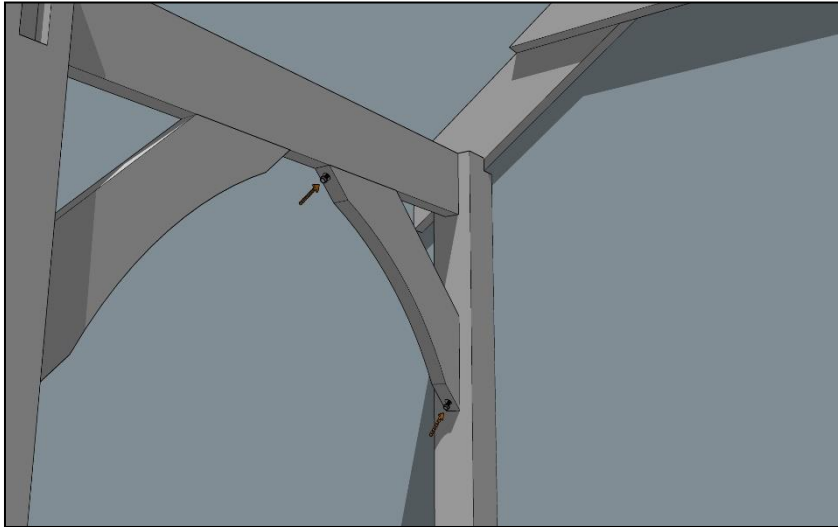

Secure braces to the underside of each side runner and against the rear posts using 2 x 70mm coach screws for a 4-post version.

## Build step 8

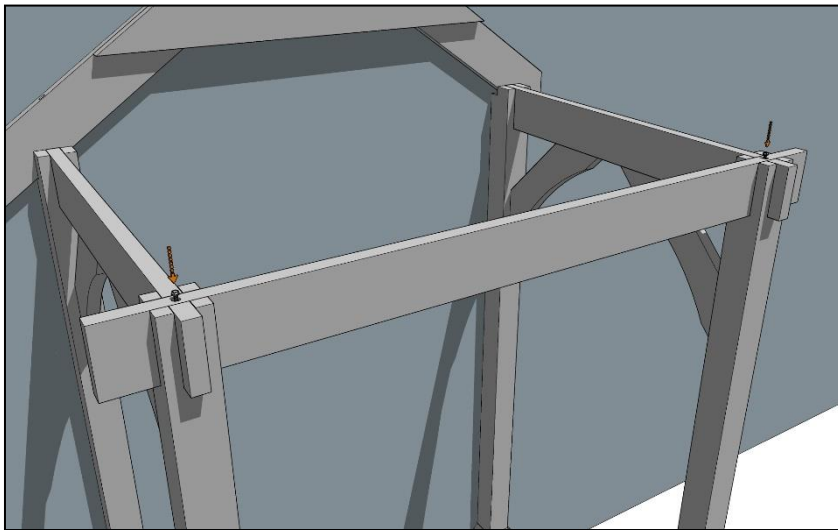

Drop the front runner into the slots as shown (adjust the spacing of the front posts as necessary if required) and drive a 200mm coach-screw into the countersunk holes as shown.



# RUTLAND PORCH RANGE

## Build Step 9

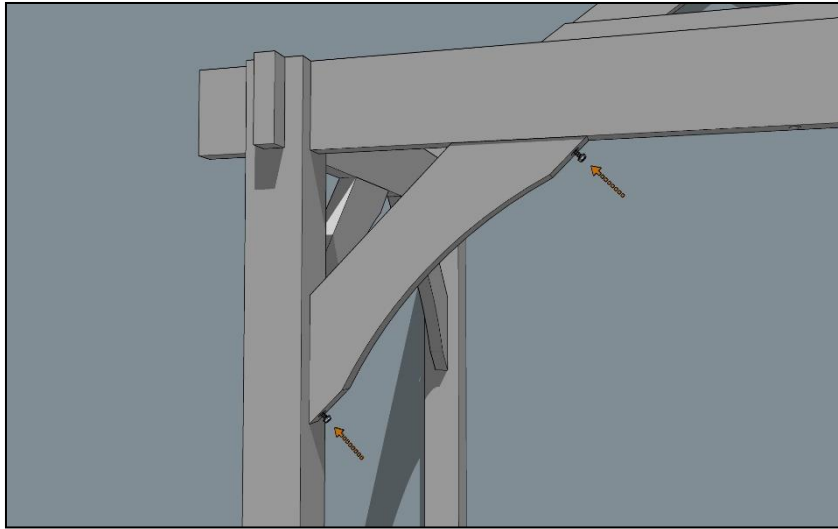

Fit the remaining braces to the underside of the front runner and front posts using 2 x 70mm coach-screws in each brace.

## Build Step 10

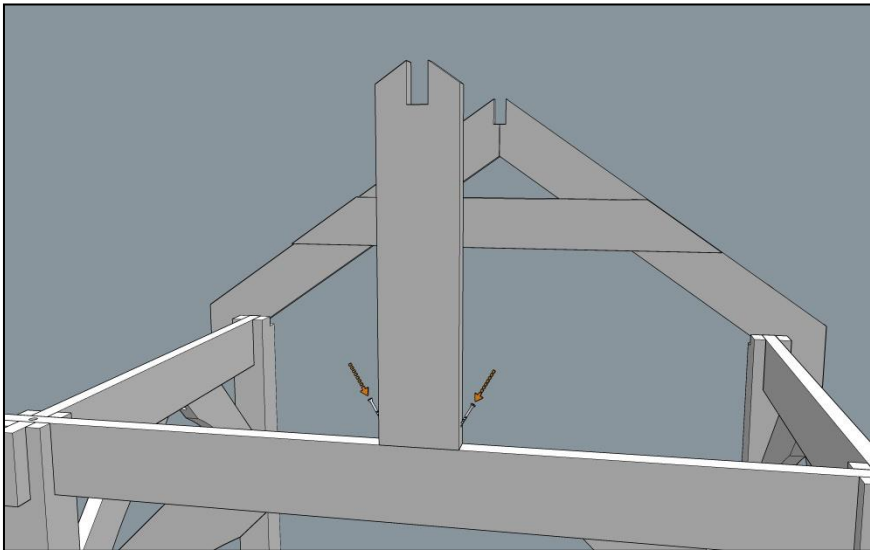

Align the king post as shown here with the marks on the front runner and drive 2 x 90mm screws into the pre-drilled holes to hold it in place.

# RUTLAND PORCH RANGE

## Build Step 11

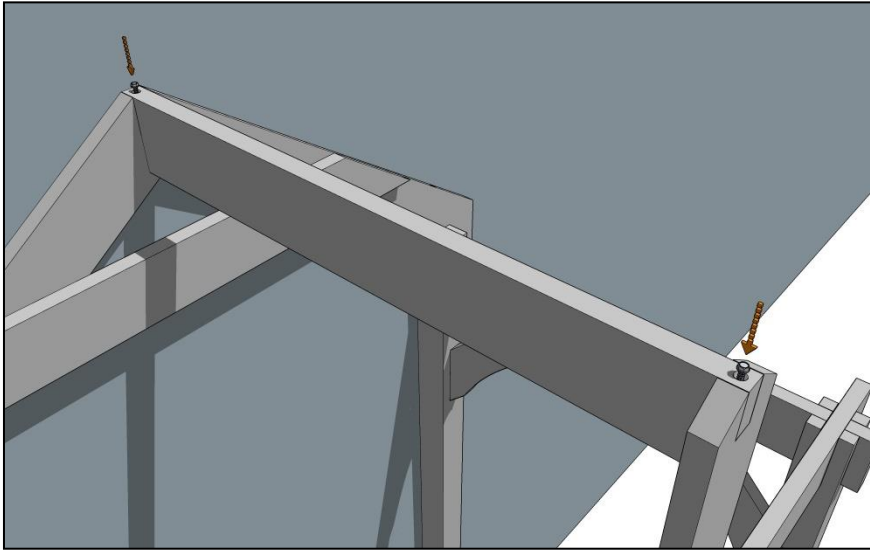

Drop the ridge piece into place and drive each end into place with 120mm coach screw.

## Build Step 12

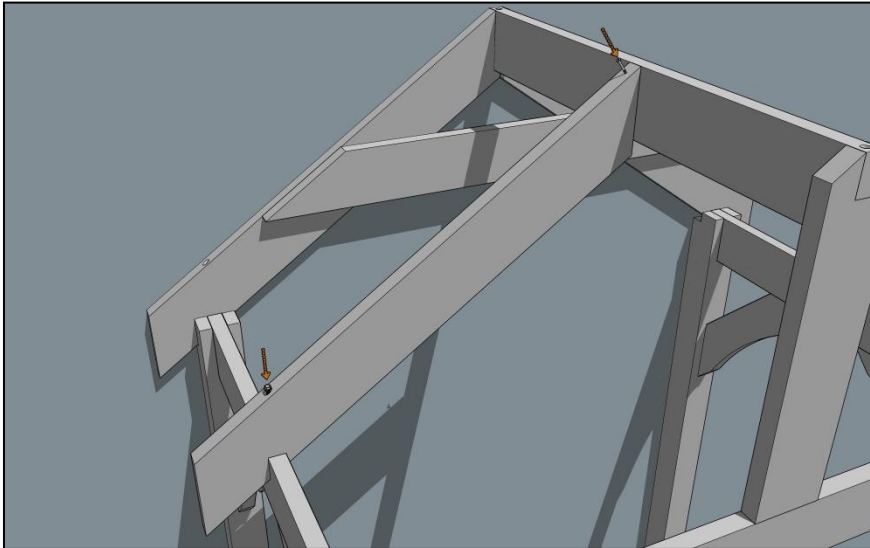

Line up the intermediate rafters with the corresponding marks on the side runners and ridge. Secure the lower end in place with 200mm coach screw and the top into the ridge with a 60mm screw through the pre-drilled hole. Attach the other intermediate rafter to the other side of the structure in the same way.

# RUTLAND PORCH RANGE

## Build Step 13

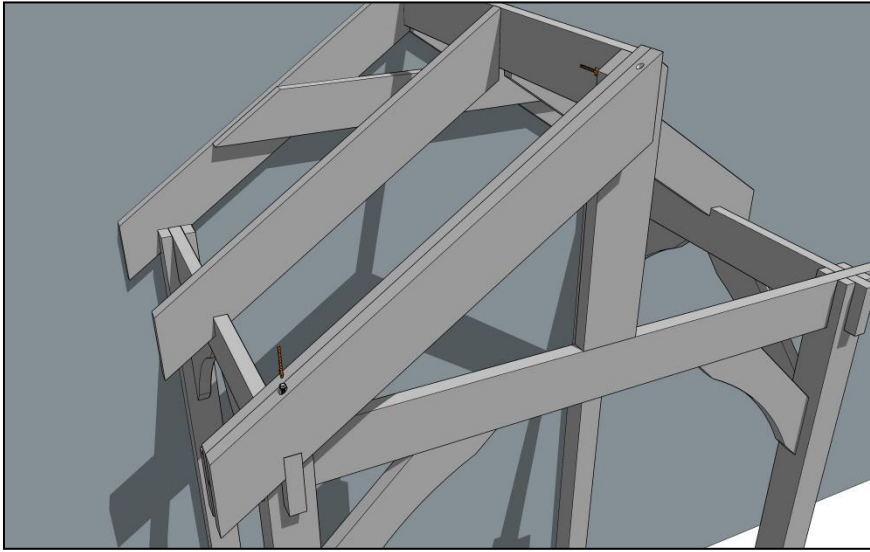

Take one of the Front runner assemblies and align it as shown, notch to the front of the structure once flush with the side runner end, drive a 200mm coach screw through the countersunk hole into top of the side runner. Repeat this process for the second Front rafter assembly.

## Build Step 14

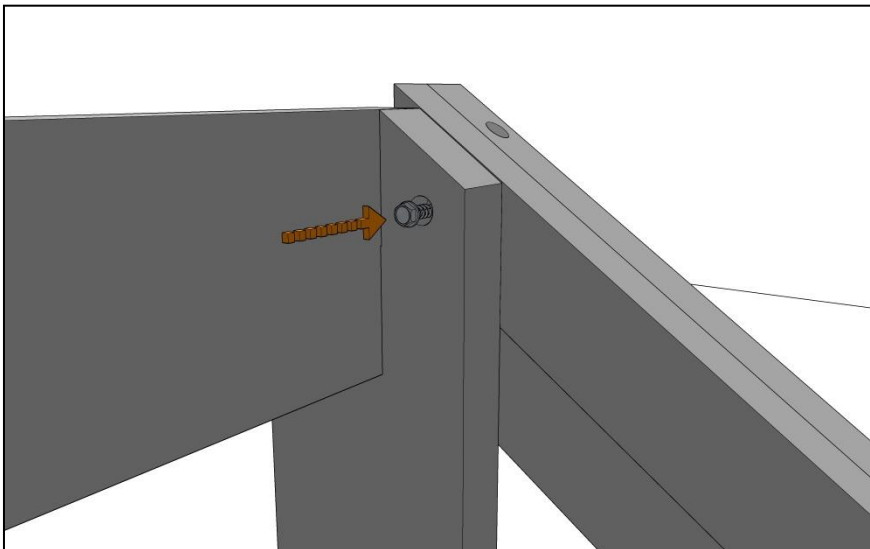

Secure the top ends of the front runner assemblies to the rear of the king post with a 50mm coach-screw through the pre-drilled countersunk hole.

# RUTLAND PORCH RANGE

## Step 15

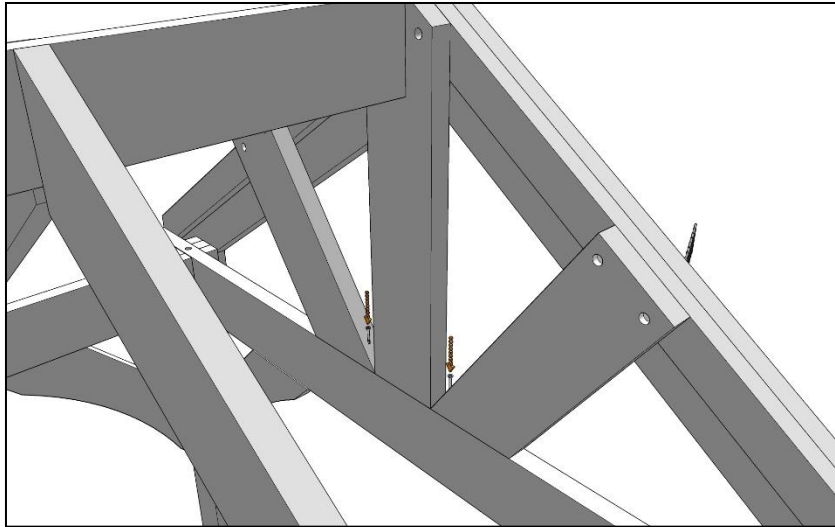

Add a fan strut to either side of the king post as shown here securing into place with a 90mm screw driven down through the pre-drilled hole into the front runner.

## Step 16

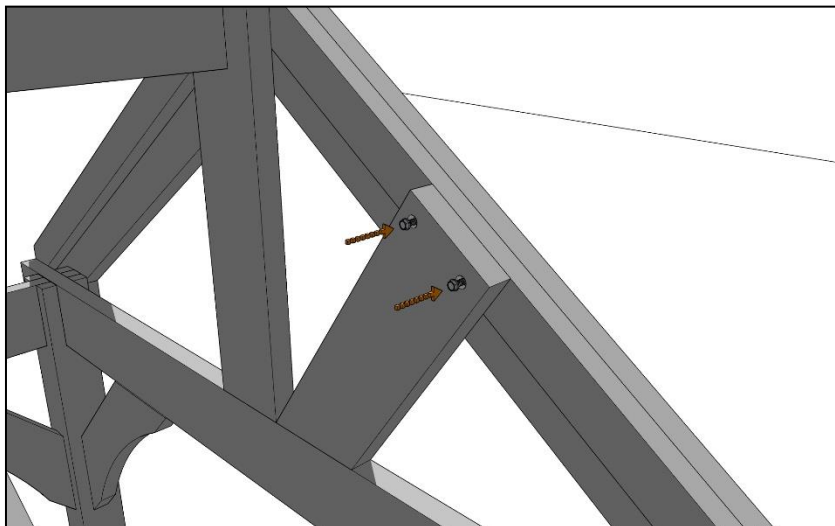

Attach the top end of each of the fan struts to the front runner assemblies with 2 x 50mm coach-screws through the pre-drilled countersunk holes.

# RUTLAND PORCH RANGE

## Step 17

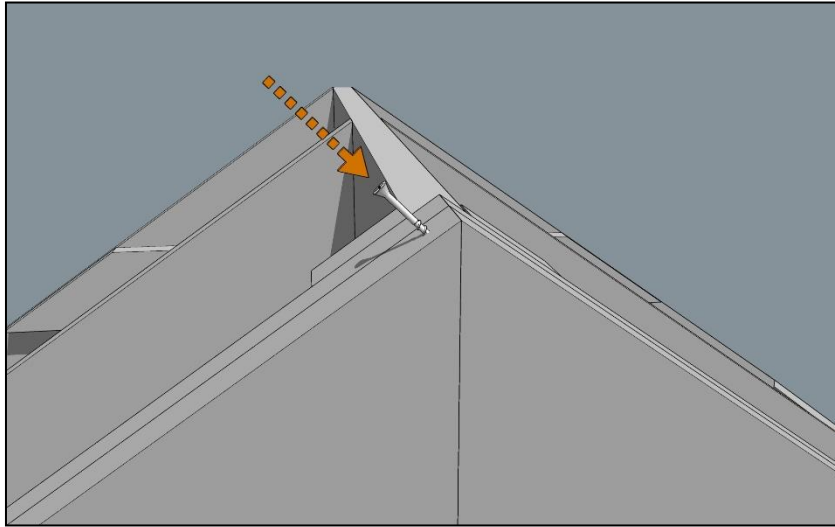

Drive a single 60mm screw through one front rafter into the peak of the second.

## Step 18

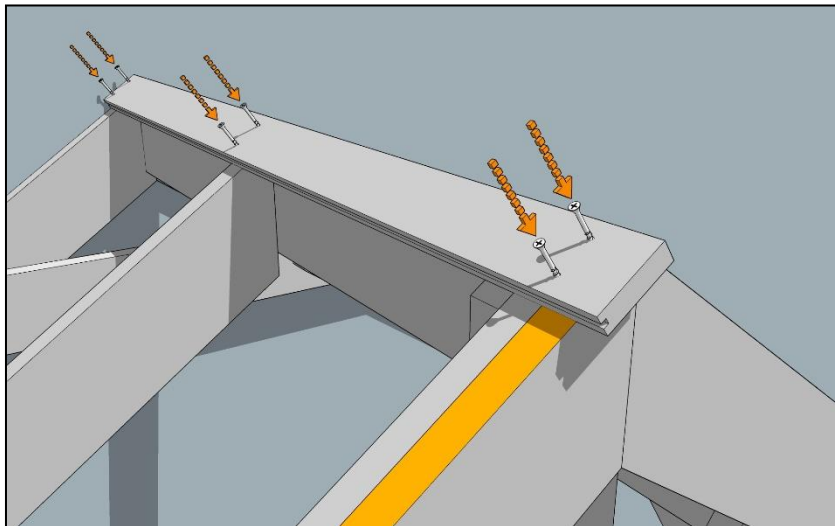

Take one of the roof slats, groove side lowermost and align it flush with the wall end of the structure and aligned to the apex before fixing in place with 3 pairs of 60mm screws into outermost and intermediate rafters (the front rafter is highlighted here in orange).

# RUTLAND PORCH RANGE

## Step 19

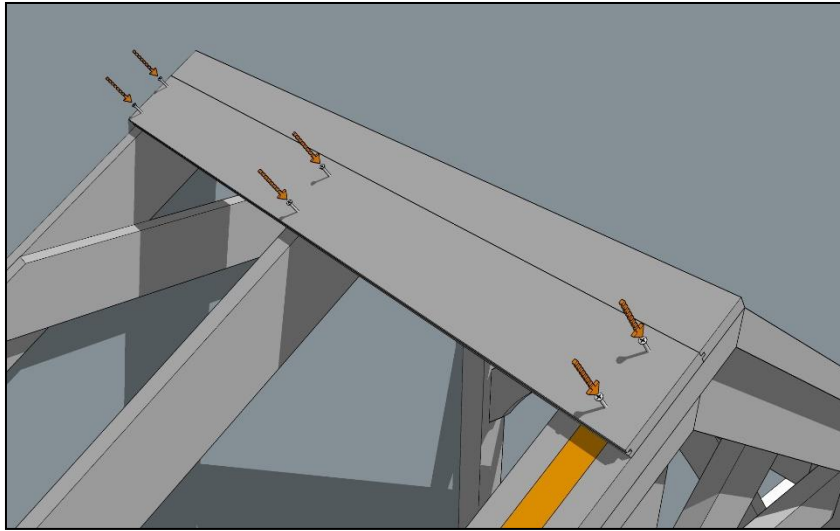

Continue working down the roof adding slats, slotting the tongue into the slat above and fixing again with pairs of 60mm screws as shown.

## Step 20

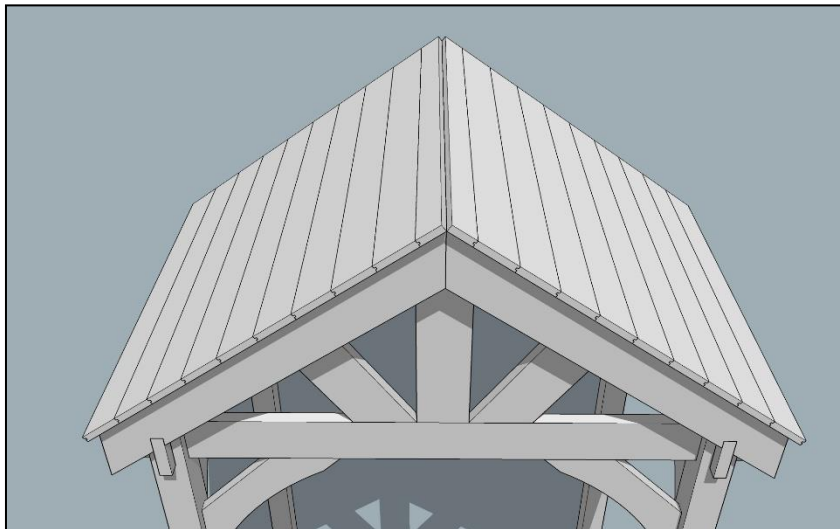

Add the roof slats to the remaining side....

# RUTLAND PORCH RANGE

## Step 21

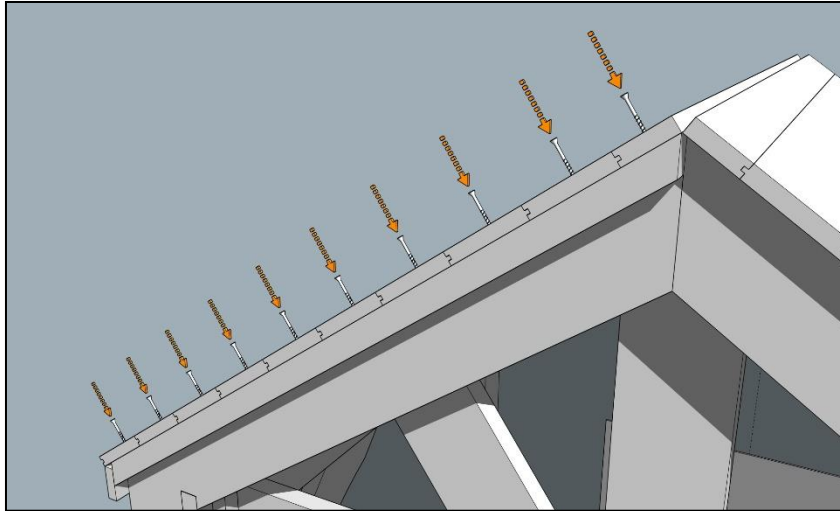

Align a Fascia trim so that the tip is adjacent to the apex and its front face is flush with the roof edge as shown here, before fixing in place with a 40mm screw through each roof slat. Affix the second trim panel to the other side of the assembly in the same manner.

## Step 22

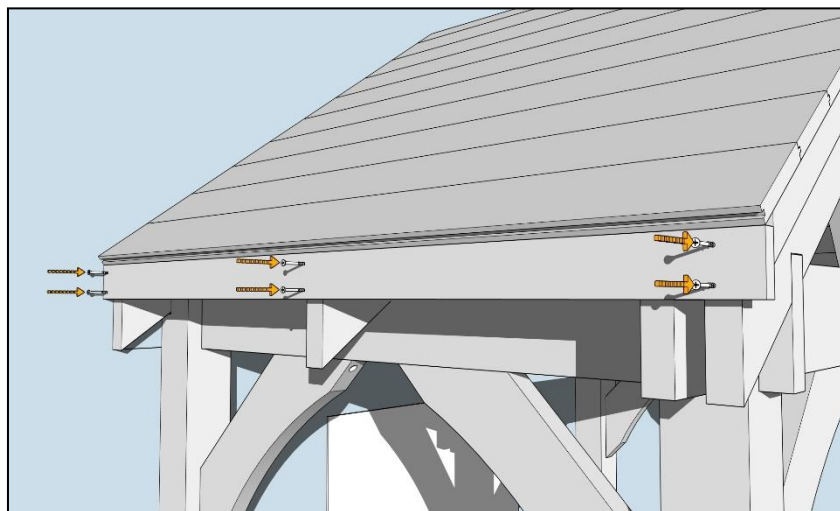

Fix the side trims in place, butted up underneath lowermost slat and flush with the wall. Use 3 pairs of 60mm screws to secure.

# RUTLAND PORCH RANGE

## Step 23

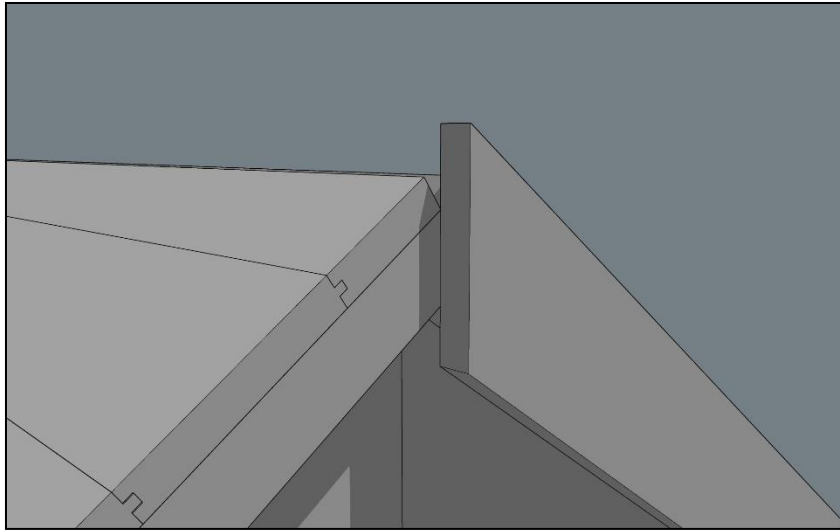

Align one of the fascia panels as shown so it coincides with the central join.

## Step 24

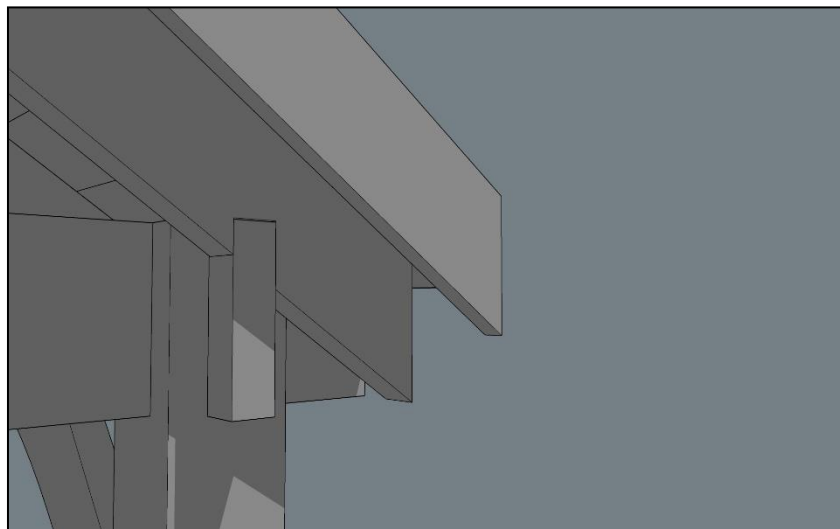

The fascia panel should run parallel to the roof and be around 20-25mm above the roof slat level.



# RUTLAND PORCH RANGE

## Step 25

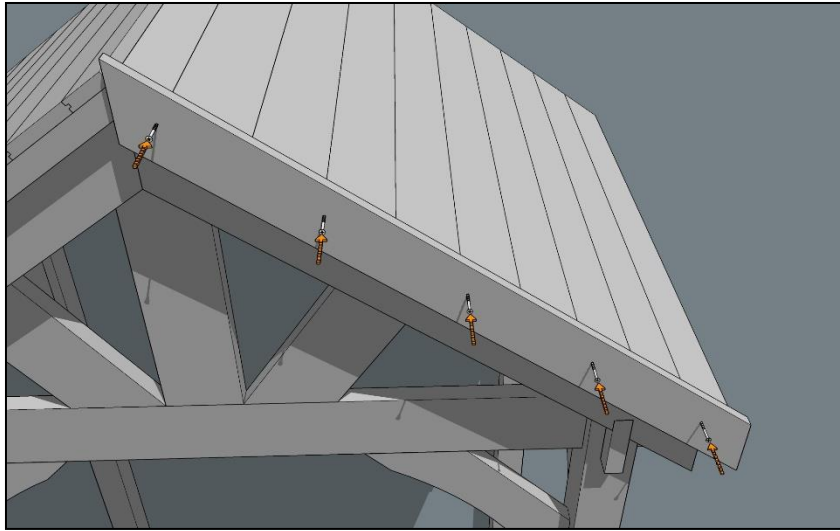

Now fix in place with 40mm screws through the fascia panel into the front of the structure. Affix the 2<sup>nd</sup> fascia panel in the same manner.

## Step 26

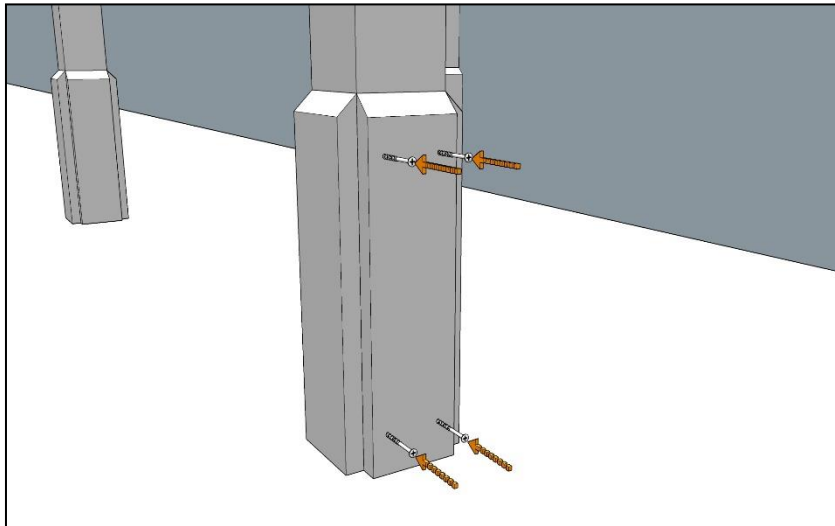

Finish off the posts by fixing a cladding panel to each visible face of the posts with 4 x 60mm screws as shown.

RUTLAND PORCH RANGE

# ROOF COVERING

**Slate roof – page 19**

**Felt roof – page 23**

# RUTLAND PORCH RANGE

## Step 1

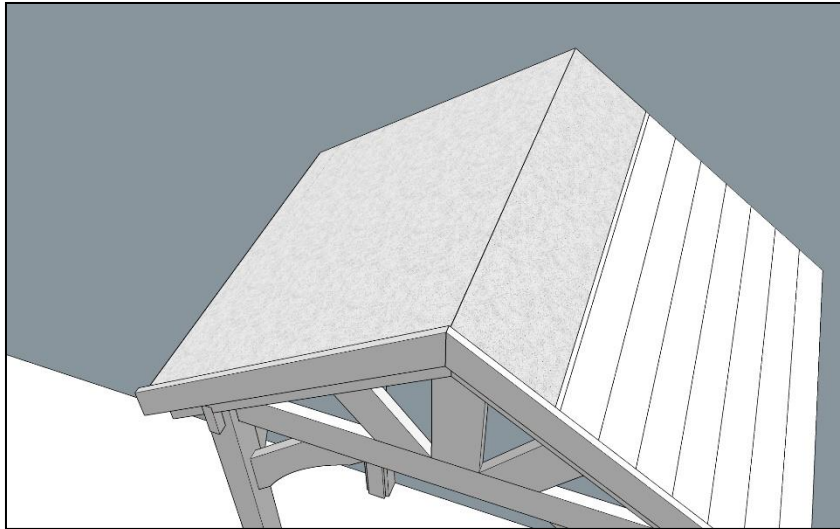

Take one of the underlay sheets and position it as shown so that it sits flush with the bottom edge of the roof panel and the edge lays over onto the opposing roof panel. Tack it into place using clout nails down the edges and along the centre of the roof panel.

## Step 2

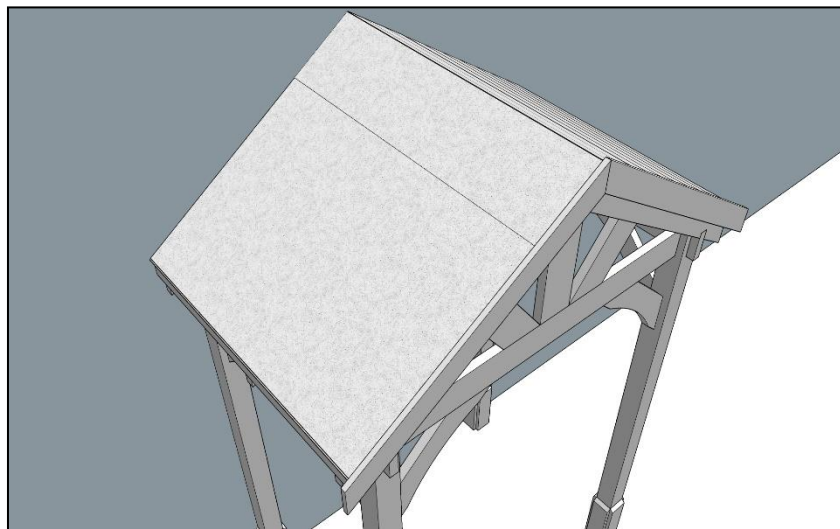

Place a second underlay sheet over the other roof panel, aligning with the bottom of the panel as before and letting the excess fall onto the opposite panel. Tack in place with clout nails as before.

# RUTLAND PORCH RANGE

## Step 3



Affix the first row of slates, starting at the wall, with a slate that has its left hand tab removed. The slate should overhang the bottom of the panel by 20-25mm before fixing in place with two 20mm screws in the designated circular area on the slate. Continue along the row adding slates. Use a slate with its right hand tab removed for the right hand slate.

## Step 4

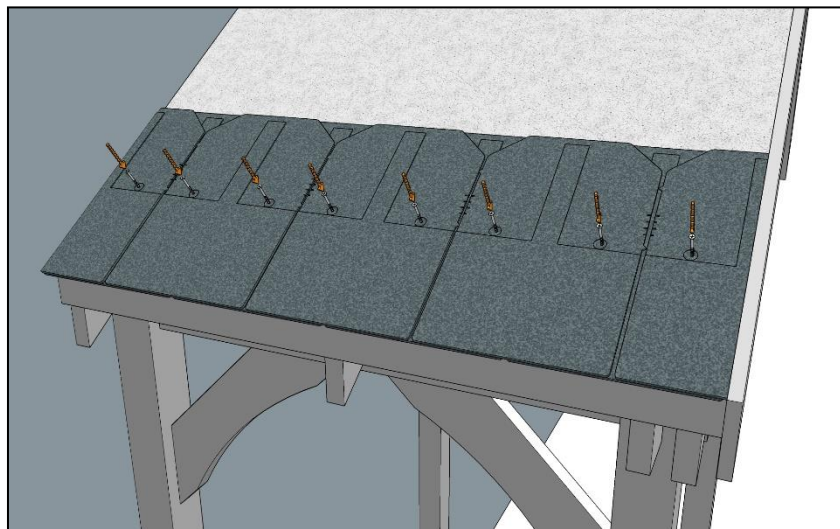

Now lay a second row over the first row, this time starting with a half left slate as shown followed by 3 whole slates and finished with a half right slate. As before, fix in place with 20mm screws through indicated circles.

# RUTLAND PORCH RANGE

## Step 5

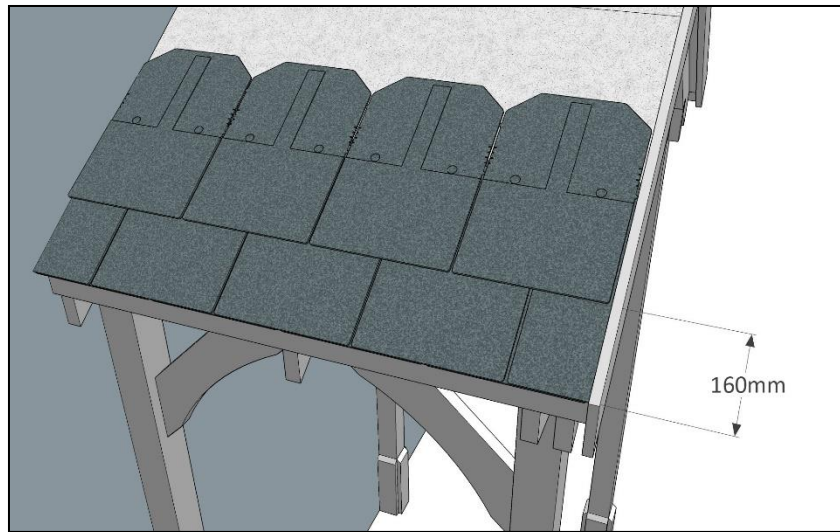

Move onto the next row, this time using 4 whole slates and outer slates with the appropriate tabs removed. These should be spaced 160mm up from the previous row before fixing in place as before.

## Step 6



Carry on adding rows as before, each one 160mm further up the roof than before and each row staggered from the previous one. Stop when you reach the apex of the roof as shown above.

# RUTLAND PORCH RANGE

## Step 7

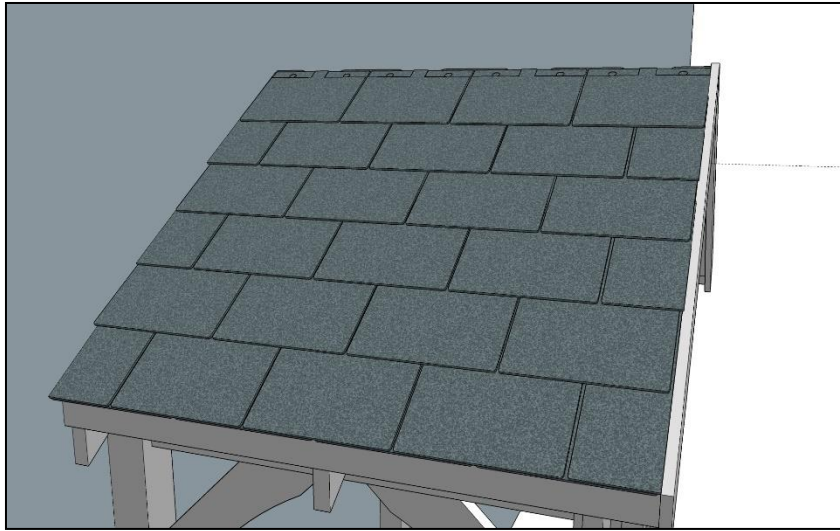

Finish off the top row using half slates, screwing them in as before and 160mm above the previous row. Repeat the slating process for the opposite roof panel.

## Step 8



Place the capping onto the apex of the roof and fix in place with 4 black dome head screws through the pre-drilled holes on each side.

# RUTLAND PORCH RANGE

## Step 1

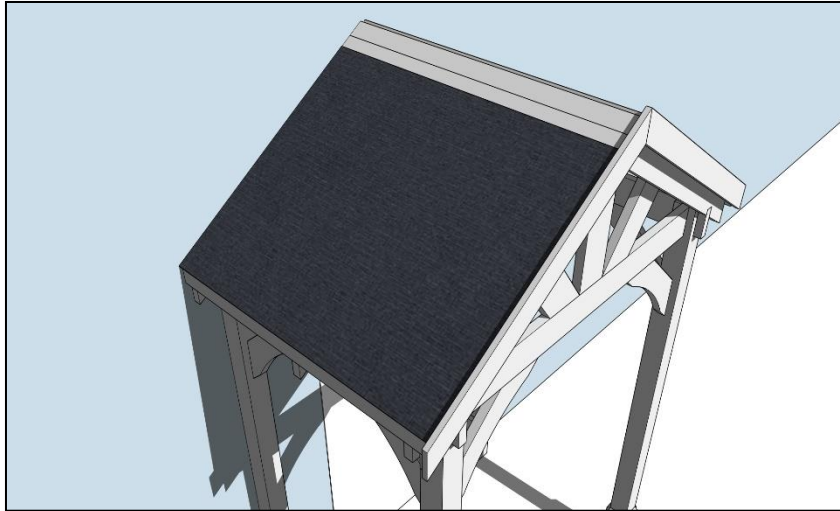

Cut 2 pieces of underlay 1200mm long and position the first as shown so that it sits flush with the bottom edge of the roof panel, the wall and Fascia panel as shown. Now tack in place with clout nails down each edge and the centre.

## Step 2

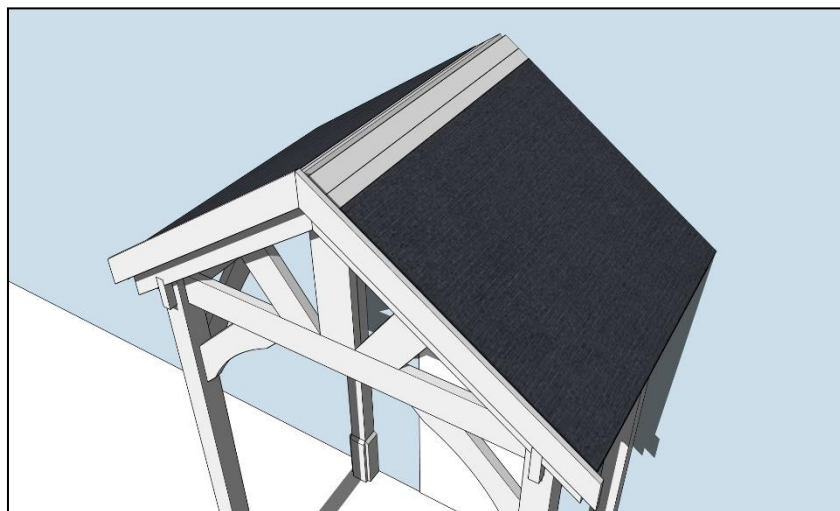

Affix the second underlay in the same way to the other roof panel.

# RUTLAND PORCH RANGE

## Step 3



Cut a piece of underlay 1200mm long and trim it so it will overlap each of the previously laid underlay pieces by at least 150mm. Apply beads of sealant across the existing underlay pieces approx. 50mm from the top edges before fixing the overlapping strip securely in place with clout nails

## Step 4

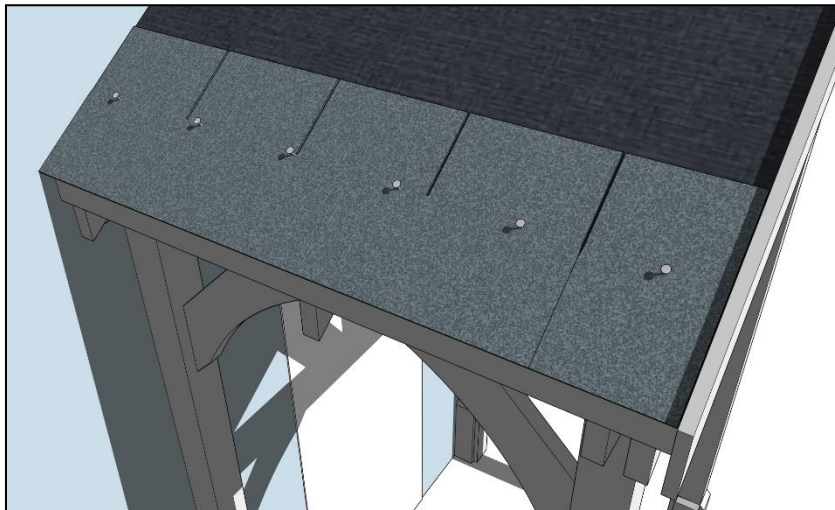

Run a bead of sealant across the bottom of the roof panel around 50mm up from the edge. Take a full felt strip, remove the tape from the adhesive portion on the reverse side and place it, tabs uppermost, flush to the wall and overhanging the roof panel by around 15mm. Cut the end off another strip to create a piece wide enough to fill the gap (200mm) between the end of the first strip and the fascia panel and place as shown after removing the tape from the adhesive on the reverse as before. Now fix everything in place with clout nails just above the centre of the strips as shown.

Rutland County Garden Furniture Ltd, Ashbourne House, 2 Dovecote Meadows,  
Aslackby, Sleaford, Lincs, NG34 0HZ.  
Company No: 11025348 VAT No: 282569762



# RUTLAND PORCH RANGE

## Step 5

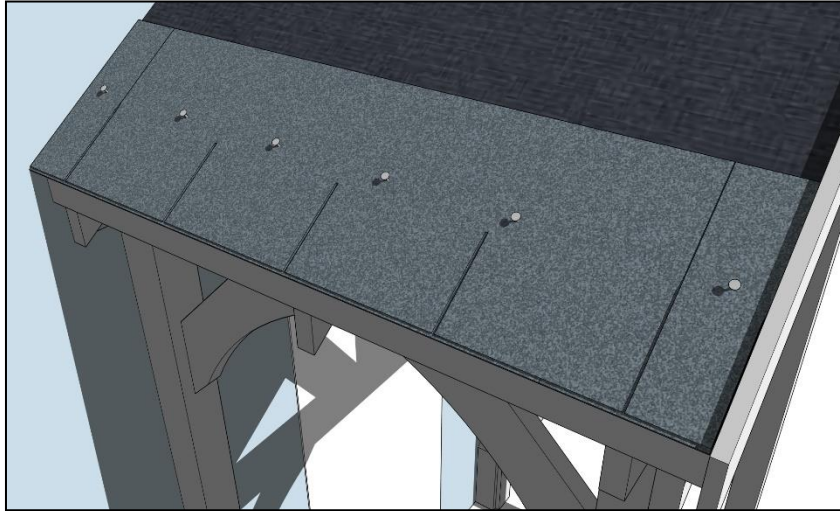

Run a bead of sealant across the existing strips, around 50mm down from the top edge. Now take a full strip, tabs at the bottom this time, and place it centred across the roof around 5mm up from the edge of the underlying strip. Fix in place with clout nails across the width of the strip just above the tabs as shown. Now cut 2 edge pieces from a strip, allowing for a 3-4mm edge gap, that will fill the gaps (96mm) from the end of the centre strip out to the wall and Fascia panel. Fix each in place with a clout nail.

## Step 6

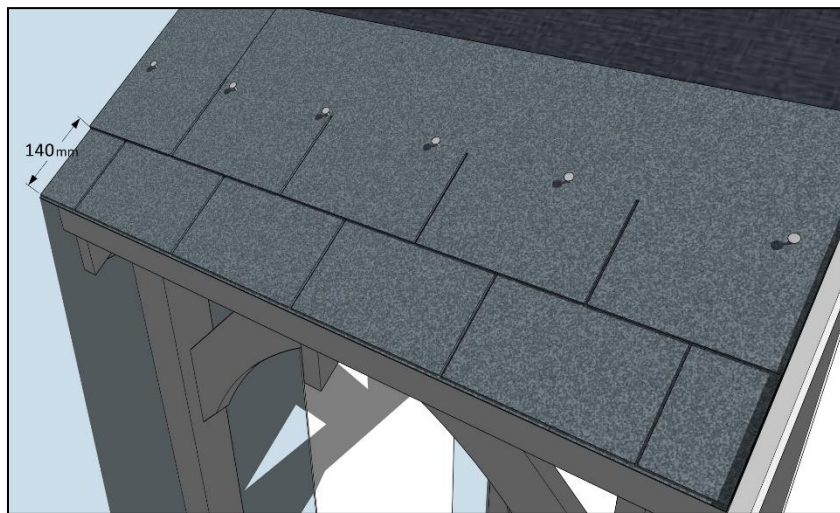

Run a bead of sealant across the roof, parallel to and about 50mm above the top edge of the strip applied in Step 5. Now take a full strip and position it adjacent to the fascia panel and 140mm up from bottom edge of the underlying felt before fixing down with a row of clout nails positioned just above the tabs. Cut a piece from another strip, 196mm wide, to fill the gap between the strip and the wall and fix in place as before.

# RUTLAND PORCH RANGE

## Step 7

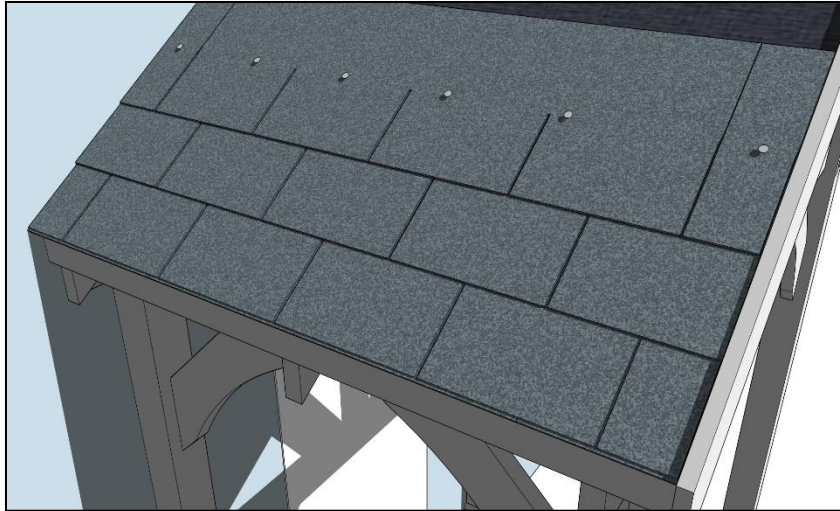

Run a bead of sealant across the roof, parallel to and about 50mm above the top edge of the strip applied in Step 6. Now take a full strip, tabs at the bottom, and place it centred across the roof and 140mm above the previous row. Fix in place with clout nails then cut 2 edge pieces from a strip, allowing for a 3-4mm edge gap, that will fill the gaps (96mm) from the end of the centre strip out to the wall and Fascia panel. Fix each in place with a clout nail.

## Step 8

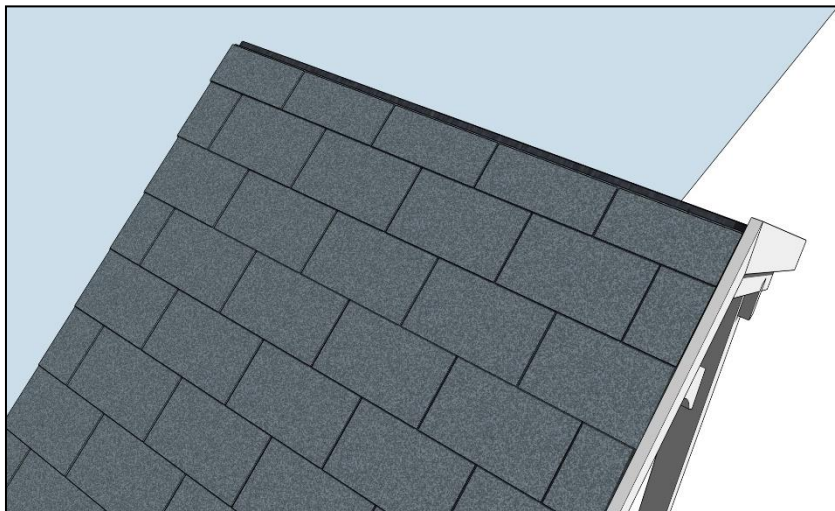

Continue adding staggered felt rows up the roof using the same method as in steps 6 and 7. When the top row of felt goes over the top of the panel, trim it off flush with the top of the panel before adding a further row and trim the final row off so the entire panel is covered as shown.

# RUTLAND PORCH RANGE

## Step 9

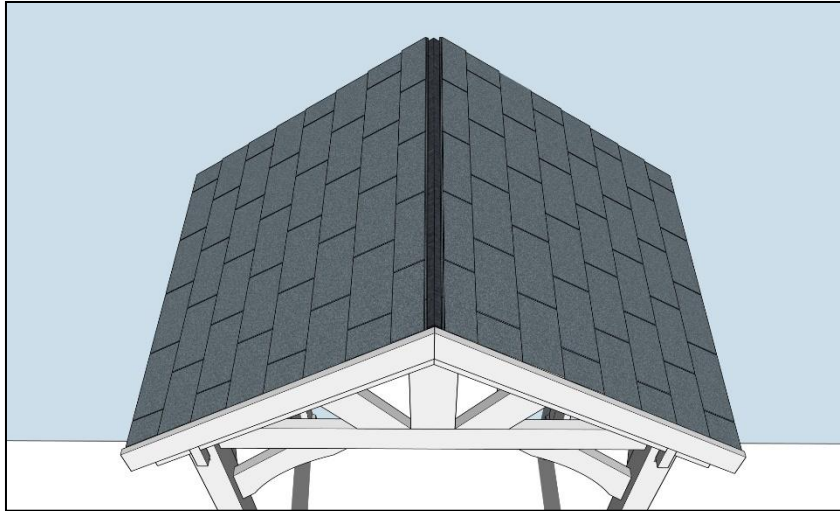

Repeat steps 4 to 8 on the other roof panel.

## Step 10

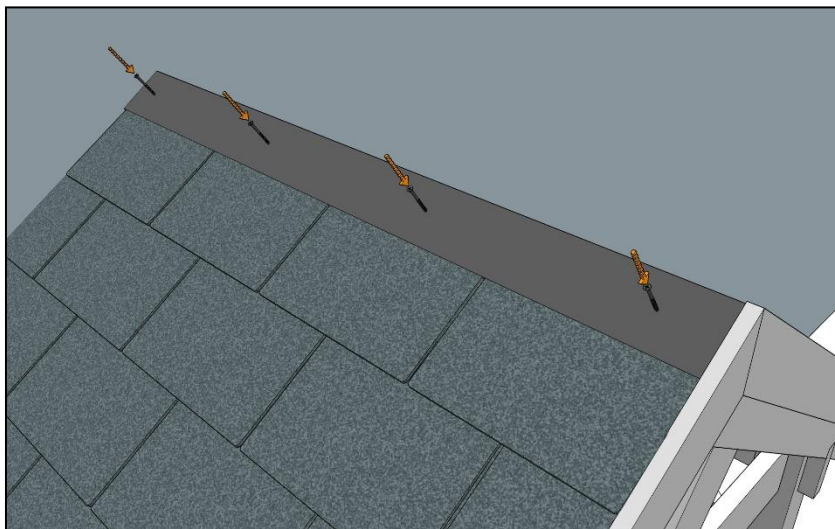

Apply a bead of sealant across the width of the roof, just below the top edges of the panels before attaching the capping in place with four dome head screws per side.

# RUTLAND PORCH RANGE

**Well done!**

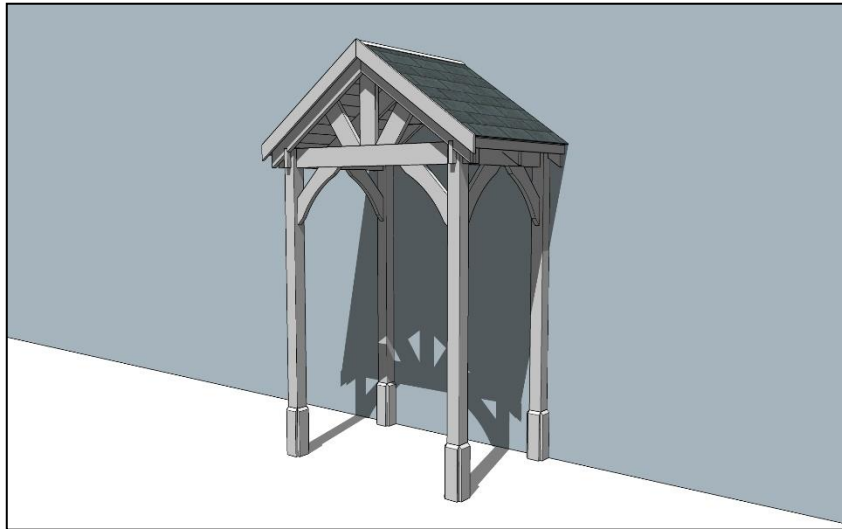

Your Rutland Porch is now complete.

WE HOPE THAT YOU FOUND YOUR PRODUCT QUICK AND EASY TO ASSEMBLE BUT IF NOT AND YOU REQUIRE ANY FURTHER ASSISTANCE OR HAVE ANY QUESTIONS YOU CAN CONTACT US BY TELEPHONE ON: 01778 440803

EMAIL: [INFO@RUTLANDCOUNTYGARDENFURNITURE.CO.UK](mailto:INFO@RUTLANDCOUNTYGARDENFURNITURE.CO.UK)

[WWW.RUTLANDCOUNTYGARDENFURNITURE.CO.UK](http://WWW.RUTLANDCOUNTYGARDENFURNITURE.CO.UK)

Rutland County Garden Furniture Ltd, Ashbourne House, 2 Dovecote Meadows,  
Aslackby, Sleaford, Lincs, NG34 0HZ.  
Company No: 11025348 VAT No: 282569762