



RUTLAND COUNTY
GARDEN FURNITURE

Hand-Crafted

ASSEMBLY INSTRUCTIONS

FELT SHINGLE CAR PORT 3 POST (5.7 & 7.2M)

Before you commence the assembly process, we recommend that you read these instructions thoroughly beforehand to familiarise yourself with the assembly process and to also check that you have the correct components. If for any reason you need assistance, you can find our contact details on the final page of these instructions.

We strongly recommend that any assembly is carried out on an open flat, level surface if possible and with sufficient space. You will also require the assistance of at least 2 adults to complete assembly safely.

If for any reason you don't feel confident in completing this project, we would recommend consulting a qualified professional to undertake the work.

Tools required:

10mm socket, No2 Pozidriv screwdriver (or electric driver), step ladder or platform.



FELT/SHINGLE CAR PORT – 3 POST (5.7 & 7.2M)

Product Specification Table

Please use the table below in conjunction with the Components list on page 3 to check you have the correct parts before commencing assembly of your carport.









	2 x 4.3M	2.5 x 4.3M	3 x 4.3M	3.5 x 4.3M	2 x 5M	2 x 6.5M	2.5 x 5M	2.5 x 6.5M	3 x 5M	3 x 6.5M	3.5 x 5M	3.5 x 6.5M	2 x 5.7M	2 x 7.2M	2.5 x 5.7M	2.5 x 7.2M	3 x 5.7M	3 x 7.2M	3.5 x 5.7M	3.5 x 7.2M
40mm Screws	20	20	20	20	20	20	20	20	20	20	20	20	20	20	20	20	20	20	20	20
60mm Screws	338	396	454	512	376	452	442	534	508	616	574	698	414	490	488	580	562	670	636	760
50mm Coach screws	4	4	4	4	4	4	4	4	4	4	4	4	4	4	4	4	4	4	4	4
70mm Coach screws	12	12	12	12	12	12	12	12	12	12	12	12	12	12	12	12	12	12	12	12
120mm Coach screws	14	14	14	14	16	20	16	20	16	20	16	20	18	22	18	22	18	22	18	22
200mm Coach screws	1	1	1	1	-	-	-	-	-	-	-	-	1	1	1	1	1	1	1	1
Posts	3	3	3	3	3	3	3	3	3	3	3	3	3	3	3	3	3	3	3	3
Wall plate	2	2	2	2	2	2	2	2	2	2	2	2	2	2	2	2	2	2	2	2
Runner	2	2	2	2	2	2	2	2	2	2	2	2	2	2	2	2	2	2	2	2
Rafter (1 x intermediate)	7	7	7	7	8	10	8	10	8	10	8	10	9	11	9	11	9	11	9	11
Brace	4	4	3	4	4	4	4	4	4	4	4	4	4	4	4	4	4	4	4	4
End brace	2	2	2	2	2	2	2	2	2	2	2	2	2	2	2	2	2	2	2	2
End panel	2	2	2	2	2	2	2	2	2	2	2	2	2	2	2	2	2	2	2	2
Fascia pieces	1	1	1	1	2	2	2	2	2	2	2	2	2	2	2	2	2	2	2	2
Tongue and groove	17	22	26	31	17	17	22	22	26	26	31	31	34	34	34	34	34	34	34	34
Tongue and groove ridge	1	1	1	1	1	1	1	1	1	1	1	1	2	2	2	2	2	2	2	2
Tongue and groove (shorter)	-	-	-	-	17	17	22	22	26	26	31	31	-	-	-	-	-	-	-	-
Tongue and groove ridge (shorter)	-	-	-	-	1	1	1	1	1	1	1	1	-	-	-	-	-	-	-	-
Cladding	12	12	12	12	12	12	12	12	12	12	12	12	12	12	12	12	12	12	12	12

FELT/SHINGLE CAR PORT – 3 POST (5.7 & 7.2M)

FELT/SHINGLE CAR PORT – 3 POST (5.7 & 7.2M)

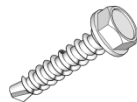
Components list

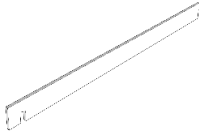
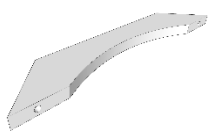
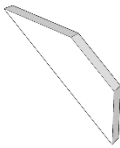
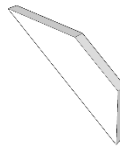
The Product Specification table on page 2 will contain quantities for the components shown below.

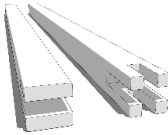
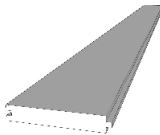
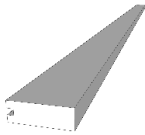
40mm woodscrews	60mm woodscrews	50mm coach screws	70mm coach screws
			
120mm coach screws	Wall plate	Runner	Rafters (+ 1x intermediate)
			
Brace	End brace	Centre brace	End cover
			
Fascia	Posts	Tongue and groove	Tongue and groove ridge
			

Please note: You will also receive a shingle roof pack separately from our supplier.

Please note: You will also receive 1 x 200mm Coach Screw (If required)

FELT/SHINGLE CAR PORT – 3 POST (5.7 & 7.2M)

Roof depth reference table

Applicable in Steps 1 & 6 of the instructions

	Panel length					
	2M	2.5M	3M	3.5M	4M	4.5M
Wall plate height - top edge*	2556	2643	2730	2817	2873	2990
Post distance from wall	1764	2256	2748	3240	3733	4225
Top of post to Top of wall plate	316	403	490	577	633	750

* The "Wall plate height – top edge" is a recommendation based upon a default post height of 2240mm. If either the wall plate height or post height is to be adjusted, please use the "Top of post to Top of wall plate", dimension A in the figure below, to calculate the new Wall plate and post heights.

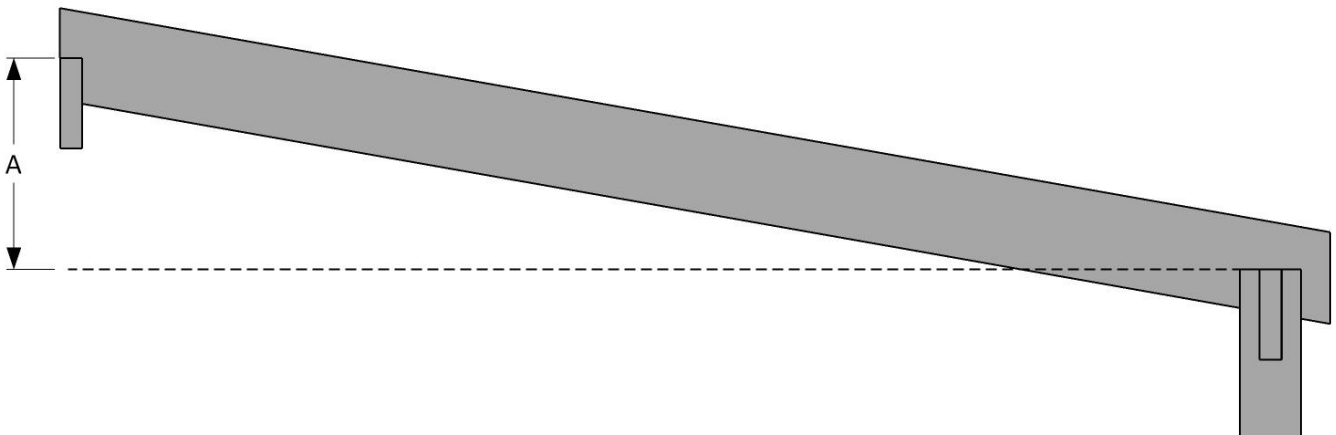

FELT/SHINGLE CAR PORT – 3 POST (5.7 & 7.2M)

Step 1

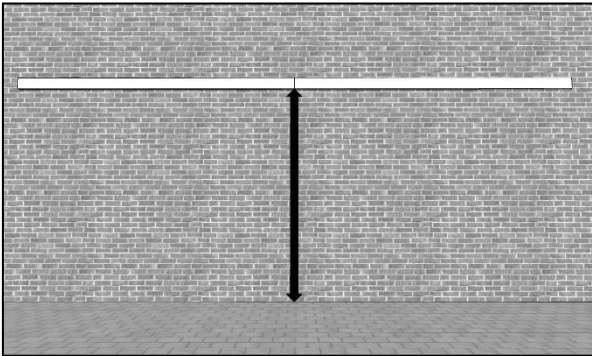

Begin by taking the wall plate(s) and placing it/them horizontally (use a spirit level or laser) on the wall where you would like the car port located. Check the Panel length table (page 4) to establish the distance from TOP of the wall plates to the floor. Mark the hole positions for your wall fixings then drill and fix them into place.

Step 2

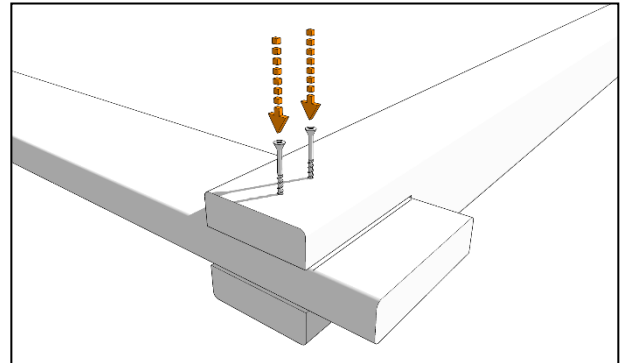

Place one of the single slotted posts on a flat surface as shown and then insert one of the runners into the post slot, using the markings on the runner as a guide. Fix into place with 2 x 60mm woodscrews.

Step 3

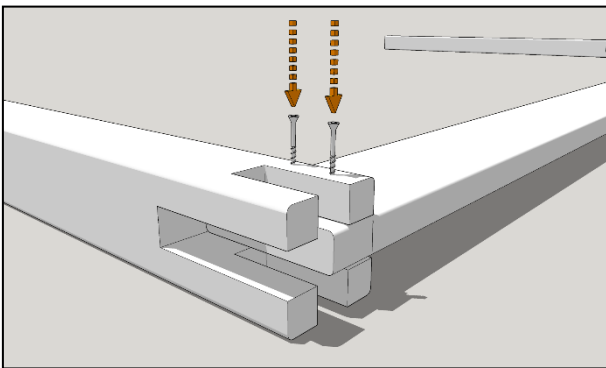

Slot a double slotted post over the other end of the runner, aligning with the single mark on the runner top edge and fix into place with 2 x 60mm woodscrews.

Step 4

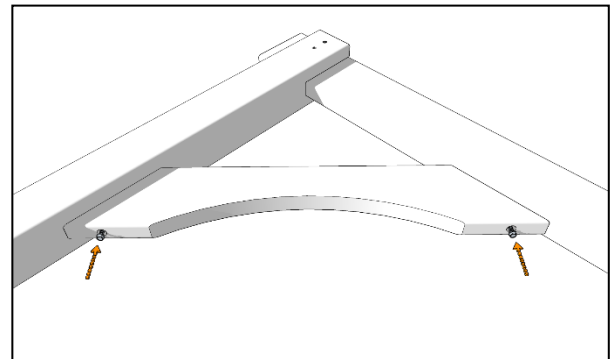

Align a brace with the underside of either end of the runner and centrally across the inside face of the post as shown. The mating faces should be flat against each other before fixing the brace into place with a 70mm coach screw at each end. Repeat and attach the remaining brace to the other end of the runner to form a "goal post" structure.

FELT/SHINGLE CAR PORT – 3 POST (5.7 & 7.2M)

Step 5

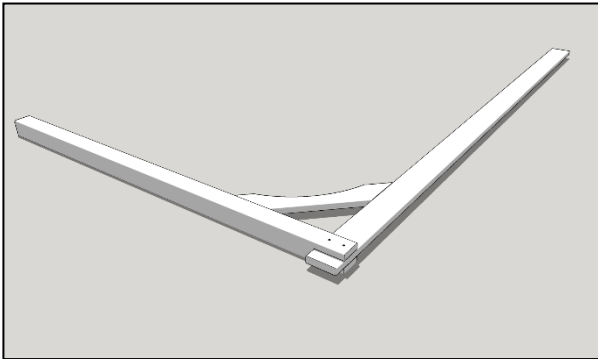

Assemble the second “goal post” using the remaining post, runner and brace in the same manner as before.

Step 6



Using your assistants, manoeuvre the previously assembled “goalpost” with 2 posts into place. Position it parallel to the wall with the central post adjacent to the centre of your wall plate(s). Consult the Roof depth reference table (page 3) to correctly distance the posts from the wall.

Step 7

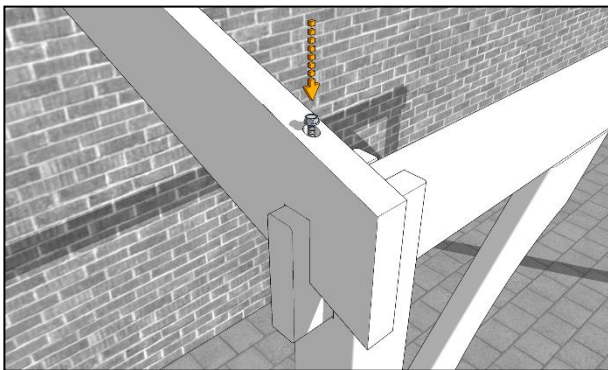

Butt the outer rafter against the outer face of the post before securing in place with a 120mm coach screw driven down into the runner.

Step 8

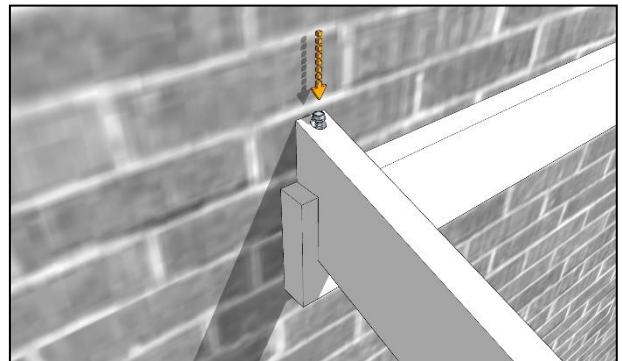

Adjust the positioning of the “goal post” if necessary, so that the notch in the underside of the wall end of the outer rafter sits snugly on the top of the wall plate and also lines up with the markings indicating its correct position. Fix in place with a 120mm coach screw driven down into the wall plate.

FELT/SHINGLE CAR PORT – 3 POST (5.7 & 7.2M)

Step 9

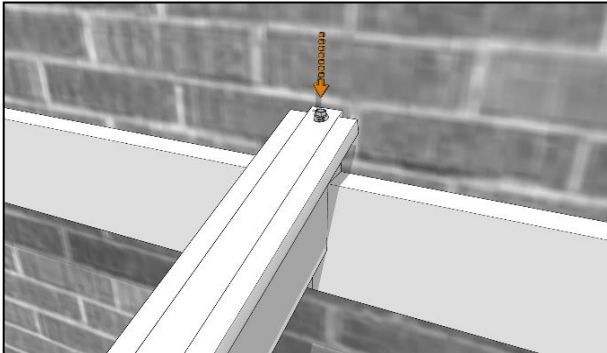

Now fix the intermediate rafter (it has battens attached to either side) into place with a 120mm coach screw driven down into the centre of the wall plate...

Step 10

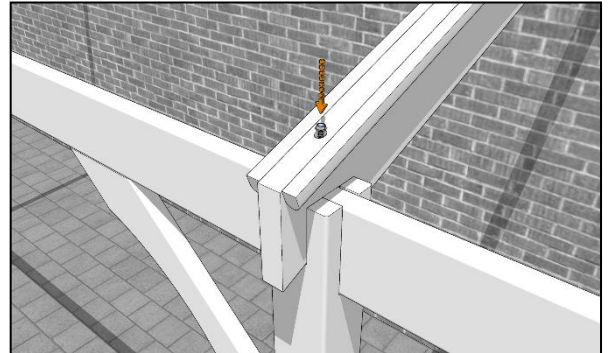

...and a 200mm coach screw down through the post into the runner.

Step 11

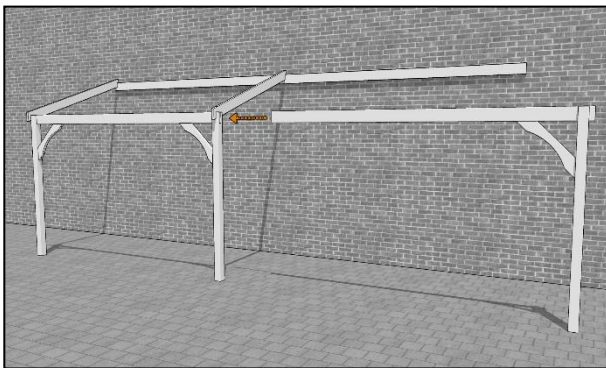

Using your assistants again, manoeuvre the previously assembled "goal post" with 1 post into place. Slide the free runner end into the slot in the centre post pushing it fully home until it butts against the other runner...

Step 12

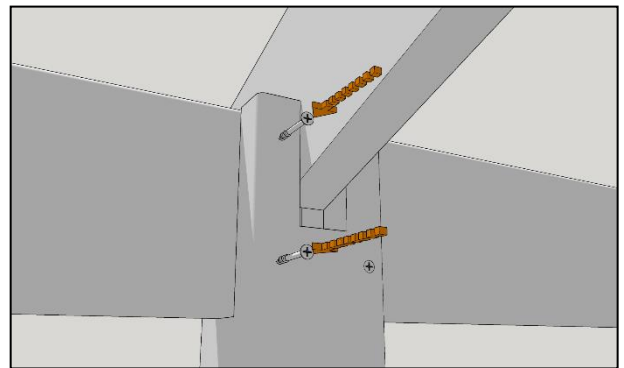

... before securing it into place with 2 x 60mm screws through the post into the runner.

FELT/SHINGLE CAR PORT – 3 POST (5.7 & 7.2M)

Step 13



Now fit the final brace into place, Aligning it the underside of the runner and centrally across the inside face of the post. Fix it into place with a 70mm coach screw at each end.

Step 14

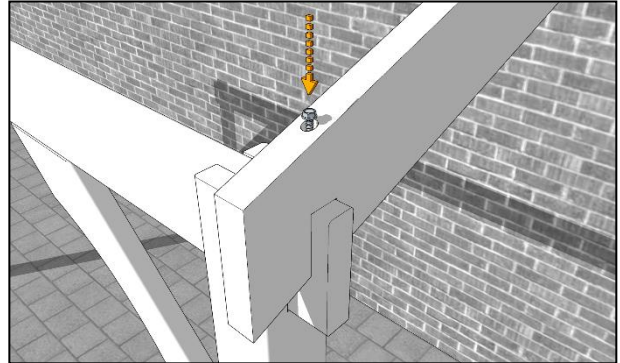

Drop the remaining outer rafter into place and fix into place as you did in steps 7 & 8.

Step 15

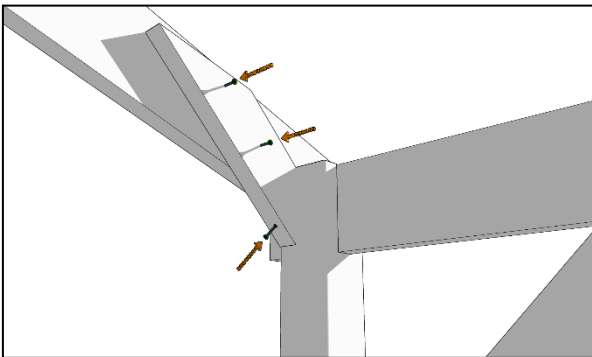

Place an end brace against the inner face of the outer runner so that the lower face is butted against the inner face of the post and the top edge is approximately 10mm from the top edge of the rafter. Fix in place with 2 x 50mm coach screws into the rafter and 1 x 70mm screw into the post as shown. Repeat for the other end of the structure.

Step 16

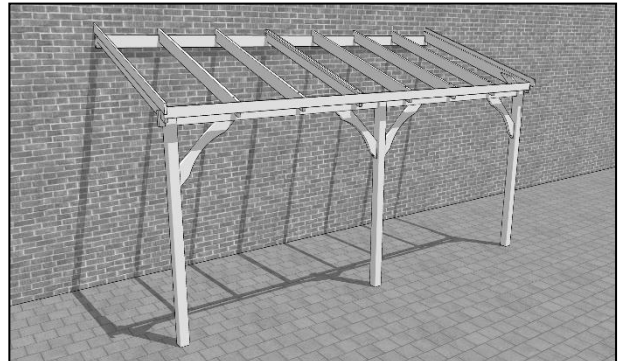

Now add the remaining plain rafters, using the markings on the runner and wall plate and fixing into place with a 120mm coach screw into the wall plate and runner as before.

FELT/SHINGLE CAR PORT – 3 POST (5.7 & 7.2M)

Step 17

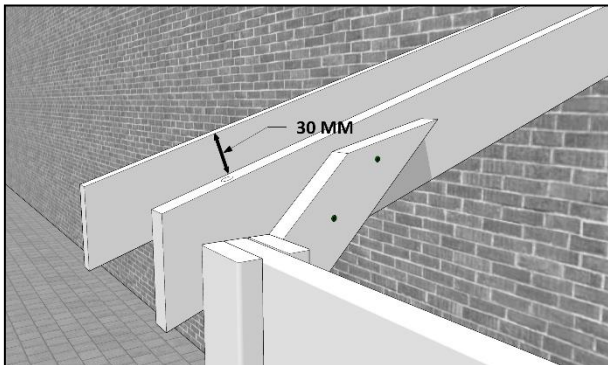

Position the end cover so that its rear edge is butted against the wall and the top edge is 30mm above the roof panel...

Step 18

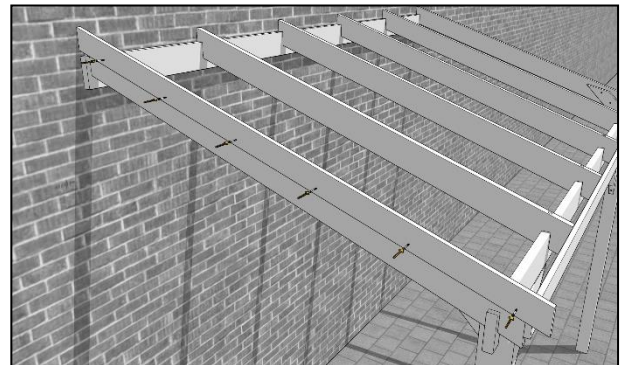

...and fix into place with 40mm screws evenly spaced around 600mm apart.

Step 19

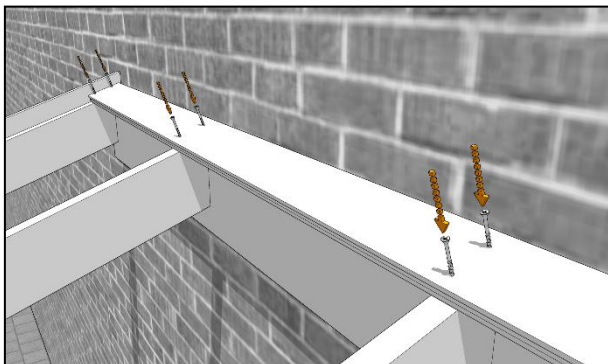

Take the tongue and groove ridge (with no tongue), groove side facing down the roof and position it at the top of the rafters before fixing into place with:
2 x 60mm screws into each rafter, spaced 20mm from the upper and lower edges for a 2M version.
1 x 60mm screw into each rafter, equidistant from the upper and lower edges for a 2.5 or 3.5M version.

Step 20

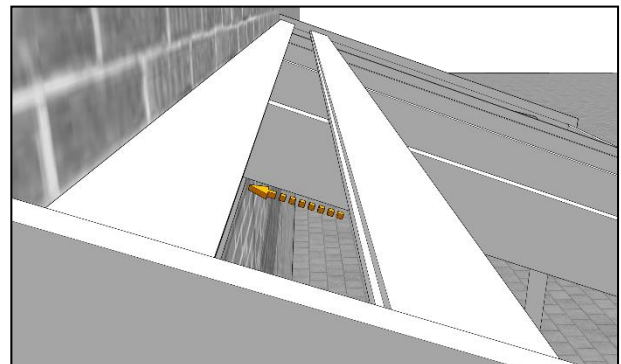

Slide a tongue and groove panel up the rafters and fully locate the tongue into the ridge piece...

FELT/SHINGLE CAR PORT – 3 POST (5.7 & 7.2M)

Step 21

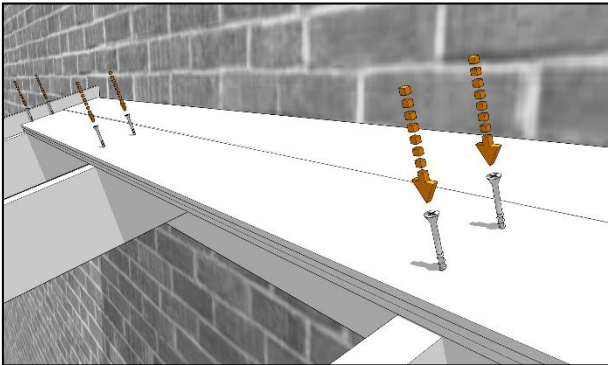

...before fixing into place with 2 x 60mm screws into each rafter, spaced 20mm from the upper and lower edges.

Step 22

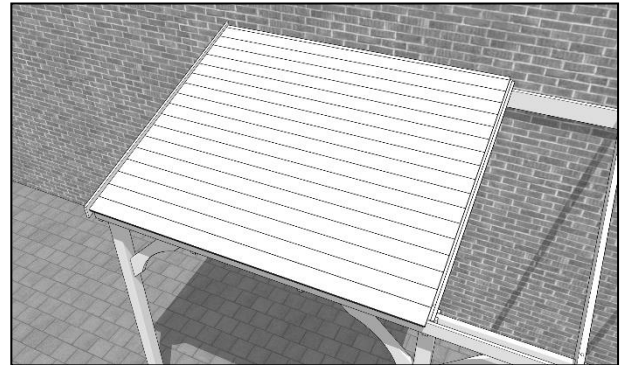

Continue adding tongue and groove panels to the half you are working on until there is just one remaining to be fitted on that side.

Step 23

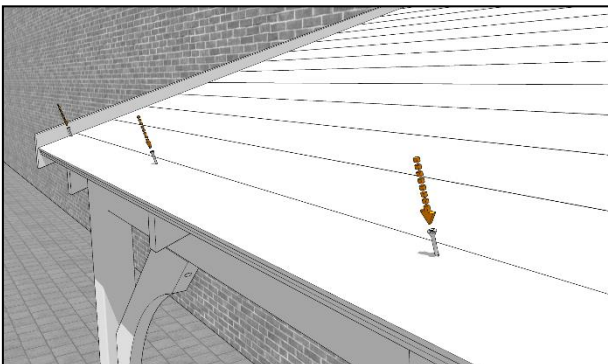

Add the final tongue and groove panel before fixing into place with a 60mm into each rafter spaced 20mm from the top edge of the panel.

Step 24

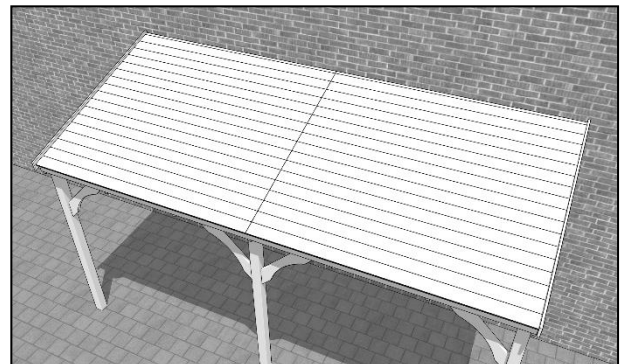

Repeat Steps 19 – 23 to complete the roof.

FELT/SHINGLE CAR PORT – 3 POST (5.7 & 7.2M)

Step 25

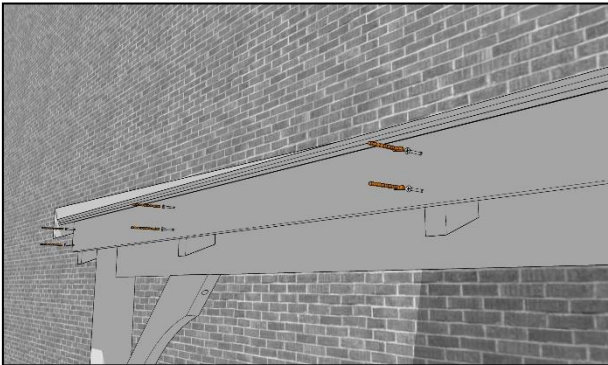

Slot a fascia panel into place so that it is butted up against the underside of the roof and against the rafter ends before fixing in place with 2 x 60mm screws into the rafter ends. Repeat for the second fascia panel and then proceed to the Shingle installation after affixing the cladding panels.

Step 26

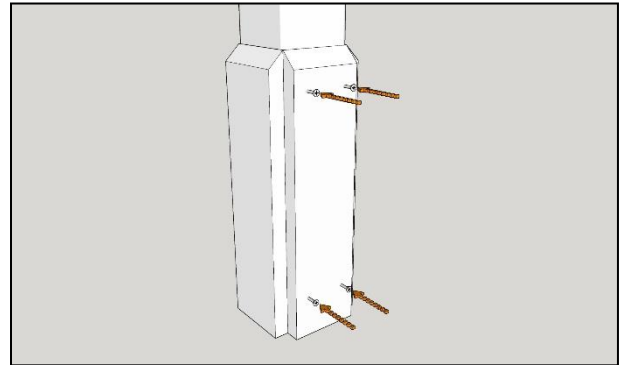





To attach cladding panels simply align as shown at the base of the post before screwing into place using 4 x 60mm woodscrews through the pre-drilled holes per panel. Repeat for each face of the post.

FELT/SHINGLE CAR PORT – 3 POST (5.7 & 7.2M)

Shingle installation

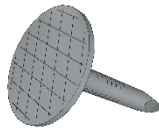
Tools required

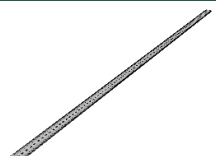
Measuring tape	Hammer	Clout nails	Sharp knife	Straight edge
				

Recommended Guidelines:

- Wear personal safety equipment during installation – Goggles, Safety Boots, Gloves
- Consider an underlay for larger projects, as this will prolong the life of your Shingles
- Install Shingles on a dry and warm day with a minimum temperature of approx. 12°C
- Make sure all loose boards are nailed down, and any loose nails are nailed flat or removed.

Applying the underlay to the roof

1. Starting at the eave (lowest part of the roof), apply the underlay butted up to the inside of the end panels and running parallel to the eave. Fix in place at the edges and rafters using clout nails or corrosion resistant staples.
2. Subsequent runs across the roof should be installed with at least a 100mm overlap as shown in figure Fig 1. Alternatively you may select a larger overlap to take up any excess and make the following step (3) unnecessary.
3. At the ridge use a straight edge and chalk to mark the top of the roof and trim any excess using a straight edge and sharp knife.

FELT/SHINGLE CAR PORT – 3 POST (5.7 & 7.2M)

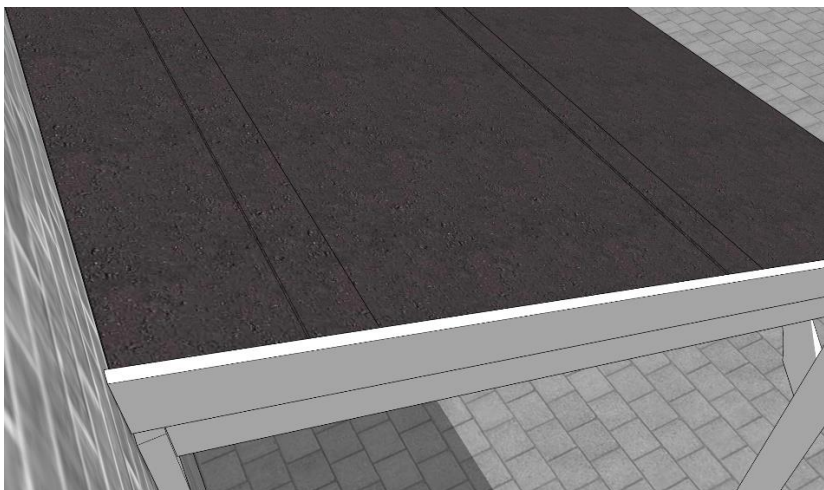

Fig 1.

Creating the eaves

1. To create the Eaves (lower roof edge) on your project, take a strip of Shingles and cut off the tabs. It is recommended to cut from the back for easy removal of the tab. Leave the self-adhesive strip covered until you are ready to apply the shingle.
2. This strip then needs to be nailed to the edge of the roof, butted up to the end panel before nailing to the eave at approx. 200mm centres. Trim any excess to butt the other end to the end panel.

Applying Shingles to the main body of the roof

1. To set the first row of Shingles on the roof, first take a strip of the shingles and trim approx. 125mm off the strip. This will need to be done at every odd course. As with the eaves, leave the self-adhesive strip until the shingle is ready to be applied
2. Apply this row to the eave of the roof, and secure with clout nails approx. 25mm above each cut out and 25mm from edges of the roof. Use a felt lap adhesive to secure the bottom edge of each shingle. It is recommended to apply the adhesive approx. 25mm from the bottom of the shingle edge. It will provide a secure fix to the roof.
3. For the second and all even courses, whole strips of shingles can be used. This will help create a staggered effect on the roof. This should be placed so the bottom of each tab is just over lapping the cut out of the tab below it. There should be approx. 145mm of the tab showing on each row.
4. On the final course of shingles, it is important to measure from the overlay point on the course below to the ridge of the roof to ensure enough overlap for the ridge detail.

We hope that you found your product quick and easy to assemble but if not and you require any further assistance or have any questions you can contact us by telephone on: **01778 440803**

Email: info@rutlandcountygardenfurniture.co.uk www.rutlandcountygardenfurniture.co.uk