



RUTLAND COUNTY  
GARDEN FURNITURE

*Hand-Crafted*

# ASSEMBLY INSTRUCTIONS

## THE AYSTON GAZEBO

Before you commence the assembly process, we strongly recommend that you read these instructions thoroughly beforehand to familiarise yourself with the assembly process and to also check that you have the correct components. If for any reason you need assistance or you believe anything is missing, you can find our contact details on the final page of these instructions.

As with all DIY projects ensure that all necessary health and safety precautions are taken such as, but not limited to, the wearing of gloves, goggles, masks and appropriate footwear – particularly if you intend to use power tools. For safety reasons, you will also need a stable platform or scaffold tower to complete this project.

If for any reason you don't feel confident in completing this project, we would recommend consulting a qualified professional to undertake the work.

### **Tools required:**

No2 Pozidriv screwdriver (an electric driver is highly recommended), Measuring tape, Scissors or craft knife, Hammer, Spirit level or Laser, Craft knife, 10mm socket or drive bit, pencil or chalk.



THE AYSTON GAZEBO

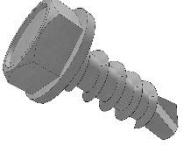
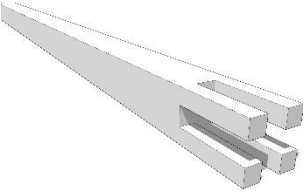
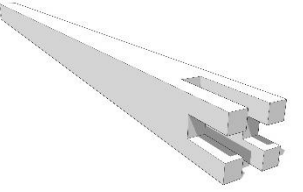
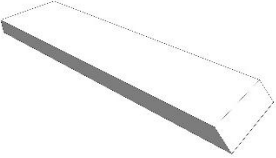
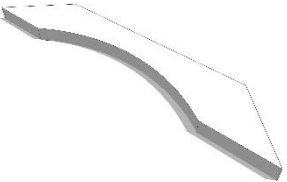
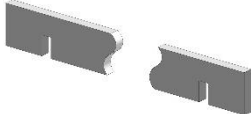
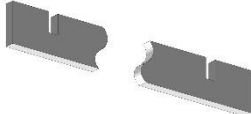
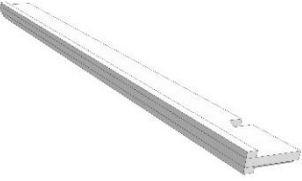
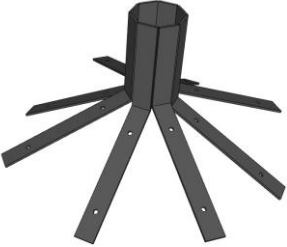
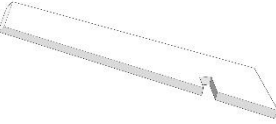
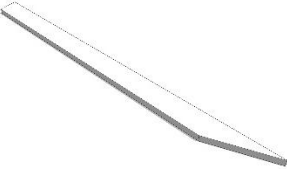

# THE AYSTON GAZEBO

## Component List

Screws – 40 & 60mm Optional 50, 70 & 90mm	Coach screws – 50, 60 & 200mm	Double slot posts	Staggered Double slot posts
			
Cladding panels	Braces	Frame rafters	Frame runners
			
End rafters x 4	Full Spider	Jack rafters	Hip joists
			

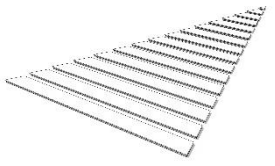
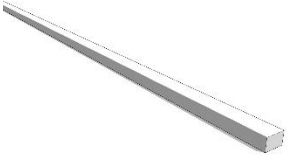
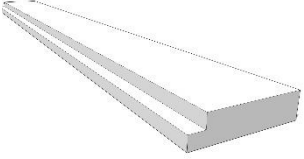
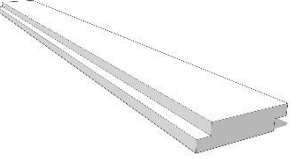
# THE AYSTON GAZEBO

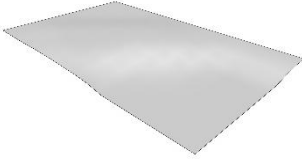
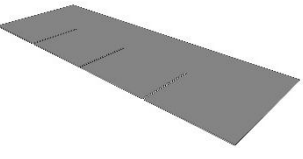
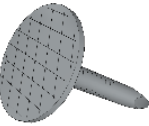
Corner tongue and groove (T&G) slats	Batten (Optional)	Bottom/Top wall slats (Optional)	Wall slats (Optional)
			

Underlay	Roof shingles	Clout nails	Sealant
			

Railing Panel (Optional)

# THE AYSTON GAZEBO

## Preparation

### Preparation

Before commencing assembly make sure that the area where you are erecting your gazebo is suitably prepared, solid and level. Work out how you will orientate the gazebo in terms of the panelled and non-panelled sides as this will affect the placement position of the braces during the early construction stages. The instructions show the process for a gazebo as shown on the cover, but the panelled end can be on the left or right.

We strongly recommend that you consider fixing your structure to the ground by concreting the posts in or using suitable feet. The positions of any post holes that are required can be worked out from the positions of the notches on the frame rafters and half runners and should be at least 400mm deep.

The posts are supplied at 2.7M in length and if necessary, should be trimmed to the correct length before commencing assembly. Bear in mind that you will typically want around 2.1m between ground level and the underside of the runners so, using this height as an example, if we were simply placing the gazebo on the ground then by adding 140mm (the depth of the runners/rafters) to the 2.1M height we would end up with a total post length of 2240mm. If we were to then concrete the posts into the ground to a depth of 400mm we would add this to the previous calculation to give a new total post length of 2640mm.

To prolong the longevity of sawn posts it is also well worth considering the treatment of any sawn ends and/or using Postsavers.

During construction of the gazebo there will be occasions where several components need to be moved into position, supported or aligned and you *will* need several assistants to help with this task, please do not attempt to undertake assembly on your own!

# THE AYSTON GAZEBO

## Build Step 1

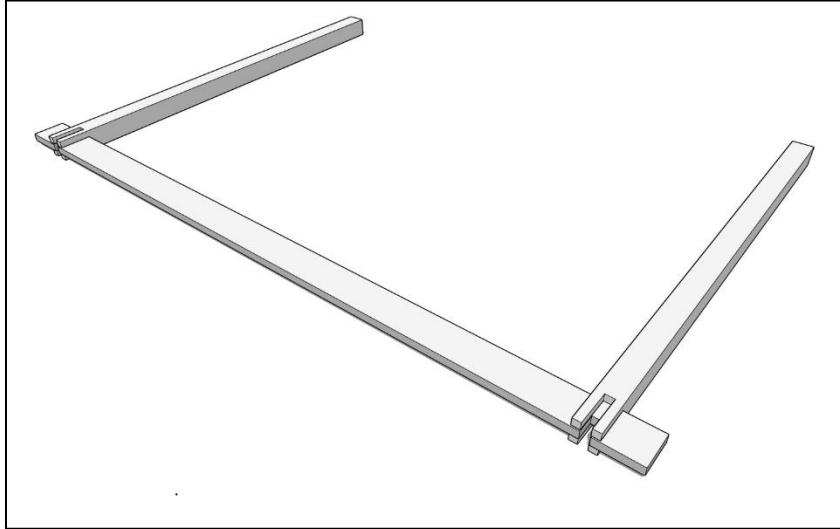

Start by laying out a Frame runner and 2 Double slotted posts as shown to make a “goalpost” structure, slotting the ends of the runner into the post slot and arranging the timbers at right angles.

## Build Step 2

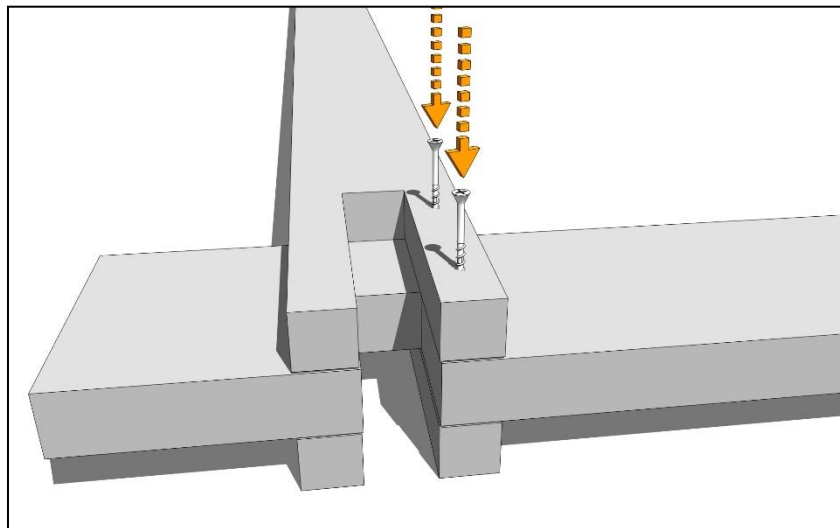

Ensure the slot in the post is properly aligned with the runner slot before fixing in place with a pair of 60mm screws. Repeat steps 1 and 2 so you have 2 “goalpost” structures.

# THE AYSTON GAZEBO

## Build Step 3

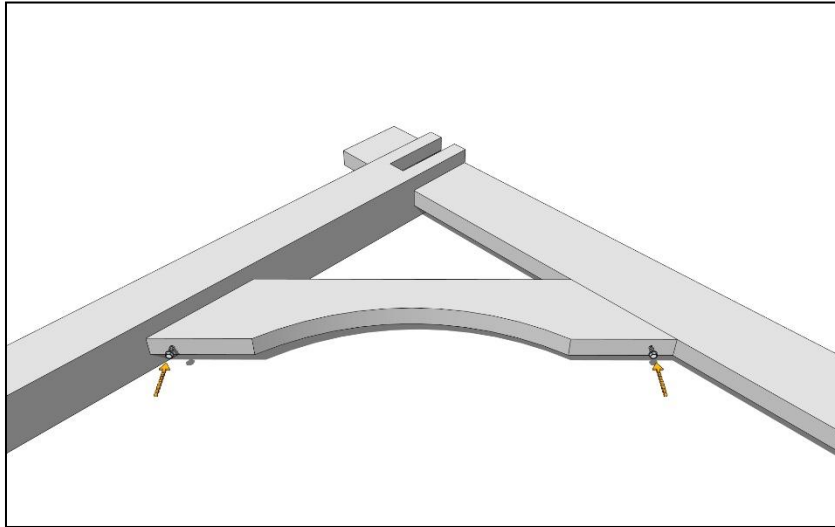

Now add braces where the posts meet the Frame runner, aligning the braces with the underside of the runner and flat against the post before securing in place with a 60mm coach-screw through each end.

## Build Step 4

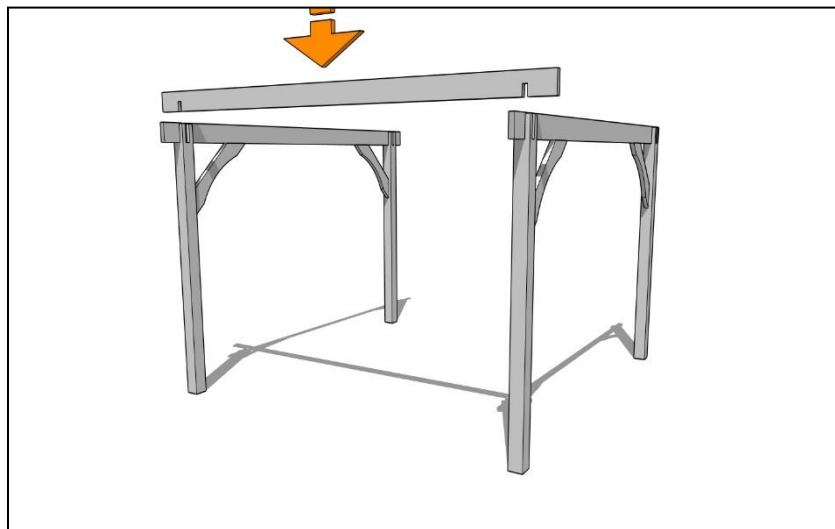

Move two of the “goalpost” assemblies into position as shown here, fixing screws from the previous stages on opposing, inner faces and get them properly aligned before lowering a Frame rafter into the notches in the two “goal posts”.

# THE AYSTON GAZEBO

## Build Step 5

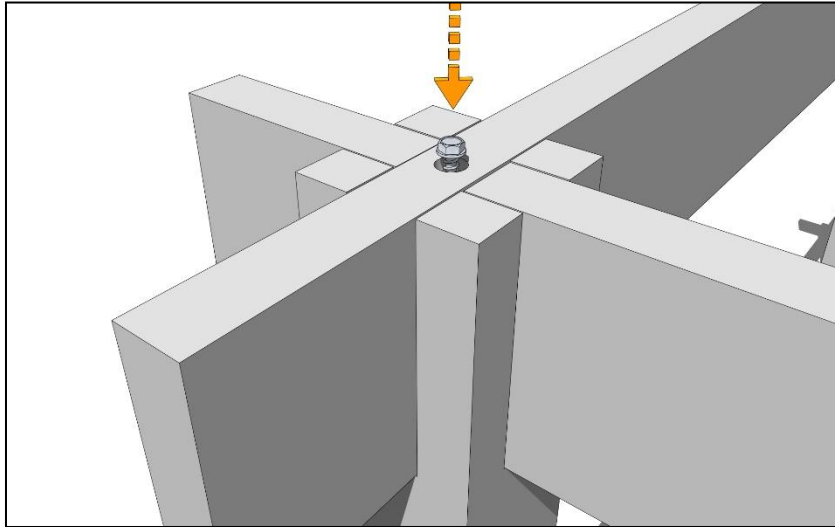

Drive a 200mm coach screw down into the hole on the top face of the rafter and through the runner into each post.

## Build Step 6

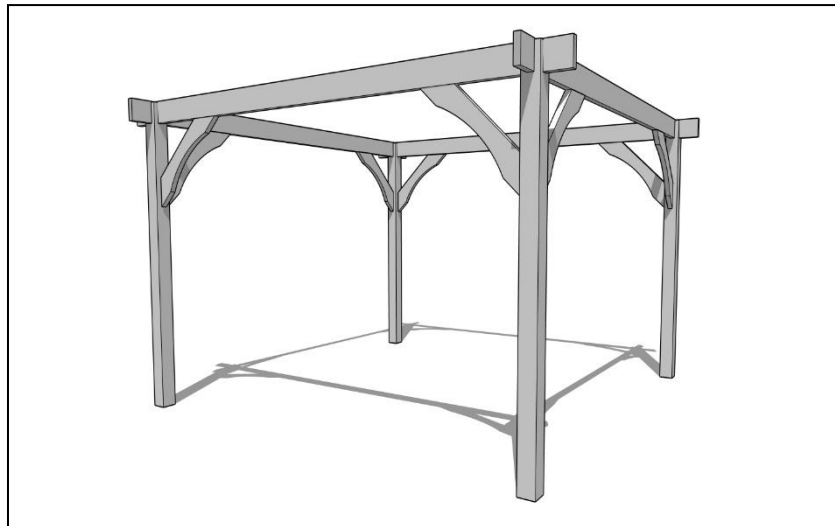

Drop the remaining rafter into place and secure with 2 more 200mm coach screws.

# THE AYSTON GAZEBO

## Build Step 7

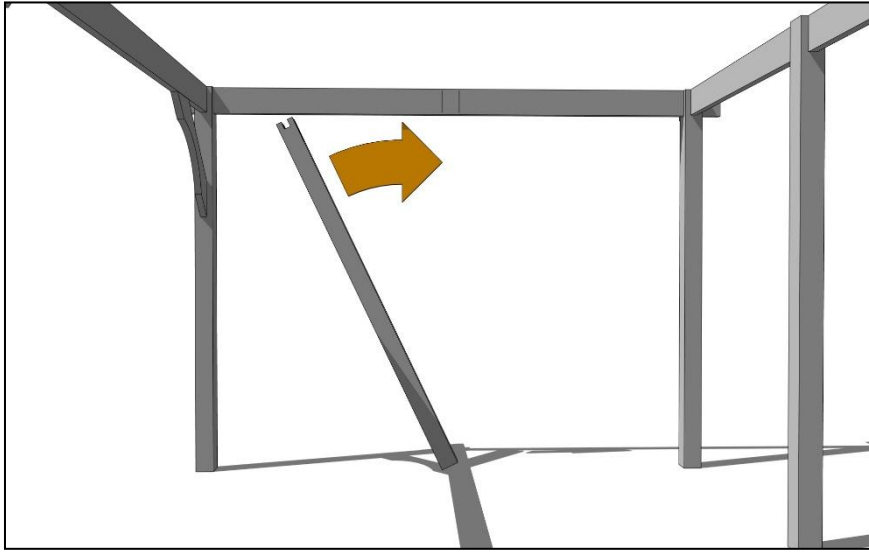

If your gazebo is to have walls or rails, we can now add the intermediate posts, centred across the runners and rafters at the positions marked on these timbers and attached to what will be the rear and side elevations of your completed gazebo. These will be a Staggered Double slot posts and the shortest notch will be located on the inner face of Frame rafter/runners. Tilt the post over as shown here and rotate into place whilst guiding the slot onto the rafter/runner until it is vertical and aligned with the markings.

## Build Step 8

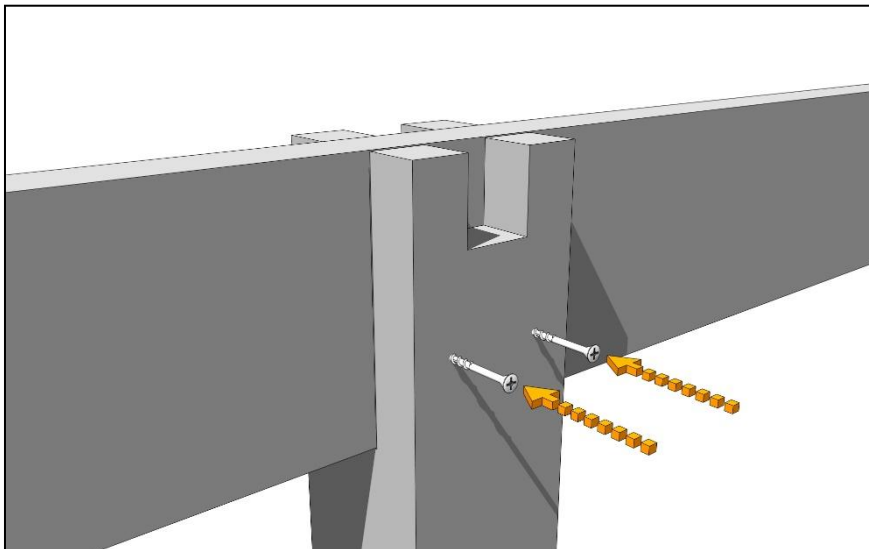

Use a level to make sure everything is correctly aligned and then fix the post in place with 2 x 60mm screws.

# THE AYSTON GAZEBO

## Step 9

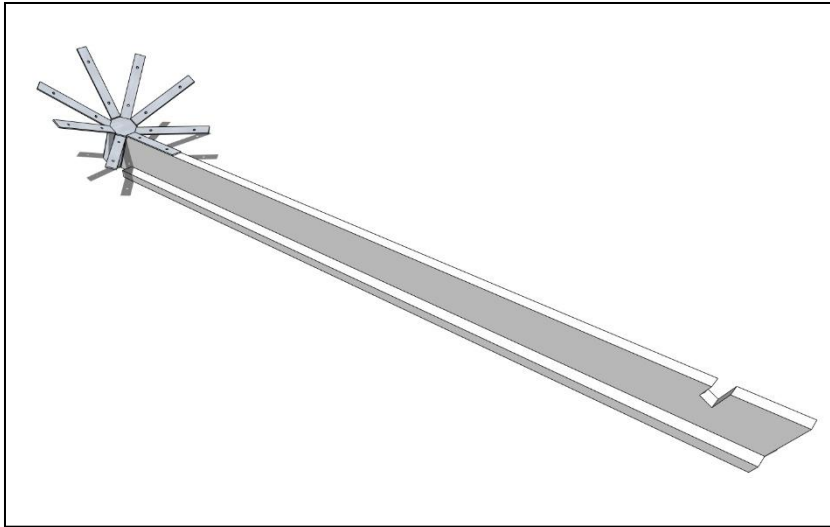

Take one of the End rafters, of which there are four and have battens pre-attached. Lay it on the ground as shown above and then align the correct spider leg (marked with a star)...

## Step 10

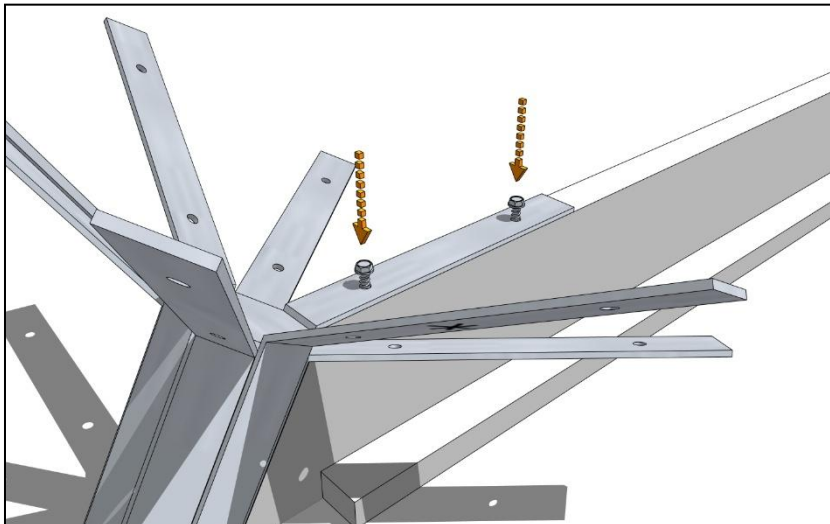

...butted up the hub of the spider and screw into place with a pair of 60mm coach-screws.

# THE AYSTON GAZEBO

## Step 11

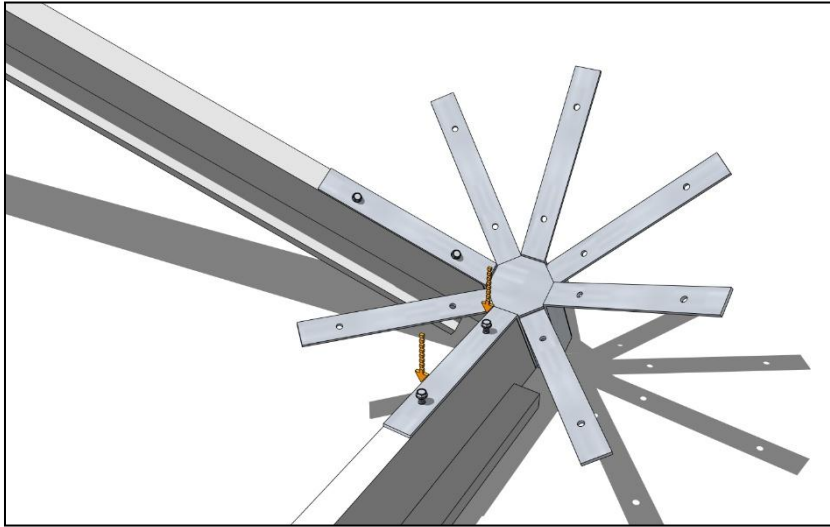

Get an assistant to elevate and rotate the first End rafter so you can add a second End rafter to the next starred leg of the spider, 90 degrees from the first, in the same way.

## Step 12

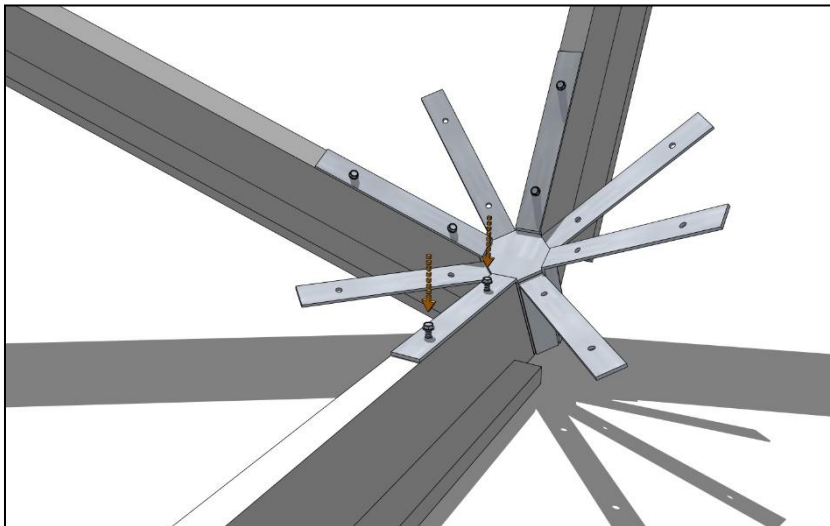

Lay a third End rafter on the ground and get a pair of assistants to again hold the spider structure in place as shown above whilst the 3<sup>rd</sup> End rafter is secured in place.

# THE AYSTON GAZEBO

## Step 13

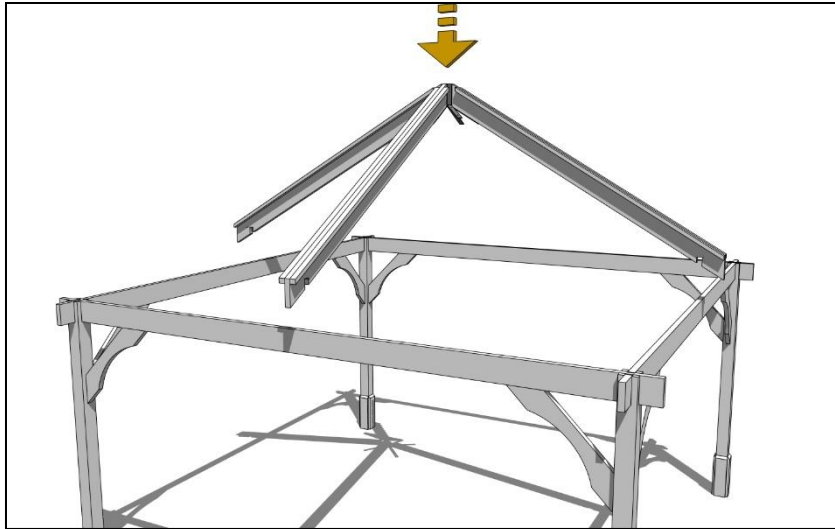

Carefully invert the End rafter structure completed in the previous stages and using your assistants, lift it into place as shown here. Lower the slots in the rafter ends onto marking on the rafter/runners or into the intermediate post tops depending on whether you also will be installing walls/rails.

## Step 14

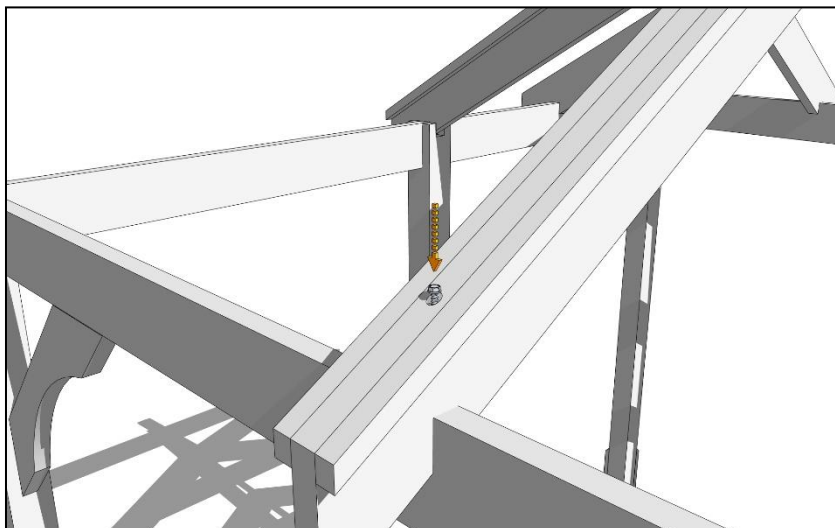

Now secure each of the End rafters in place with a 200mm coach-screw driven down into the rafter/runner/post.

# THE AYSTON GAZEBO

## Step 15

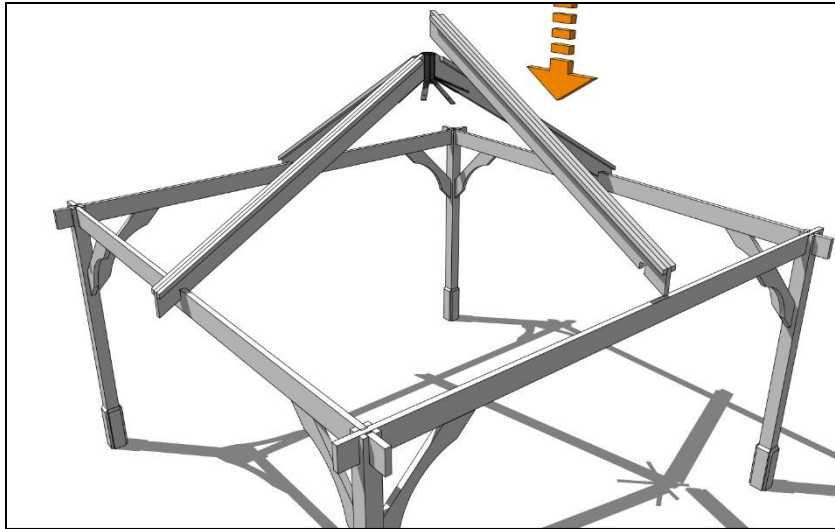

Now lower the final End rafter into place, slotting it onto the rafter/runner and post where applicable.

## Step 16

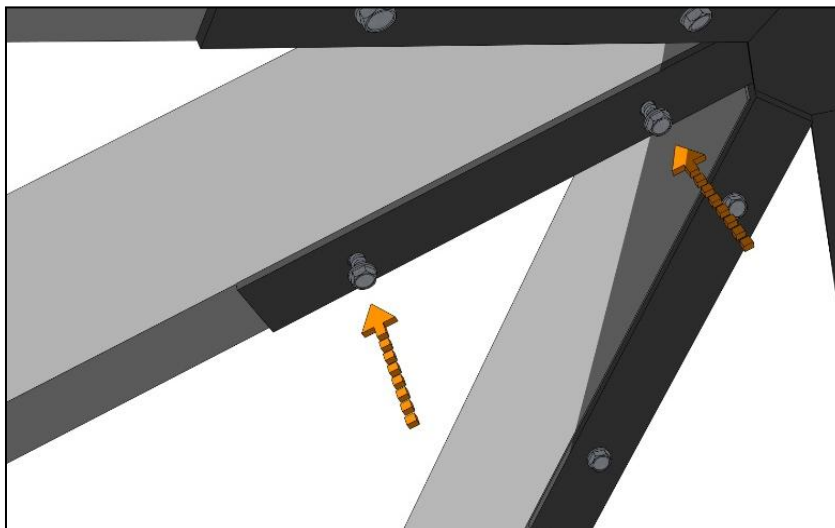

Attach the upper end to the spider with 2 x 60mm coach screws and the lower end into the rafter/runner with a 200mm coach screw as before.

# THE AYSTON GAZEBO

## Step 17

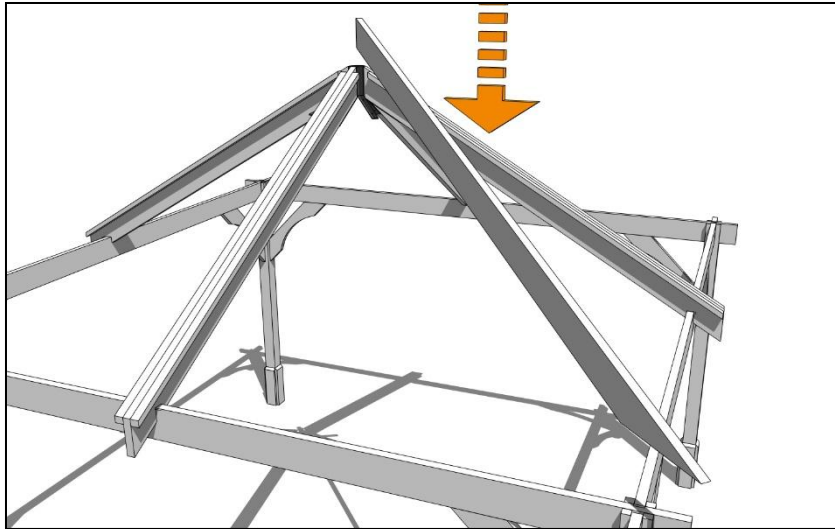

Now add the four hip joists. Start by lowering the appropriate end onto one of the remaining spider legs.

## Step 18

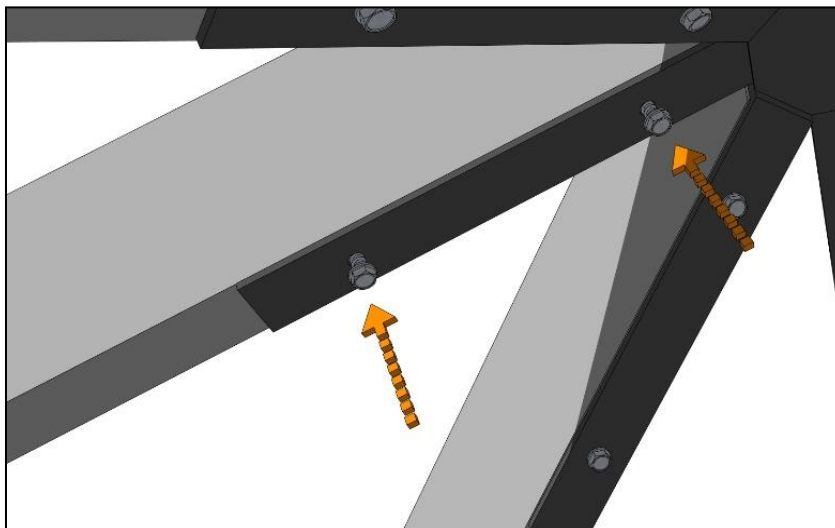

Fix the end at the spider in place with 2 x 60mm coach-screws.

# THE AYSTON GAZEBO

## Step 19

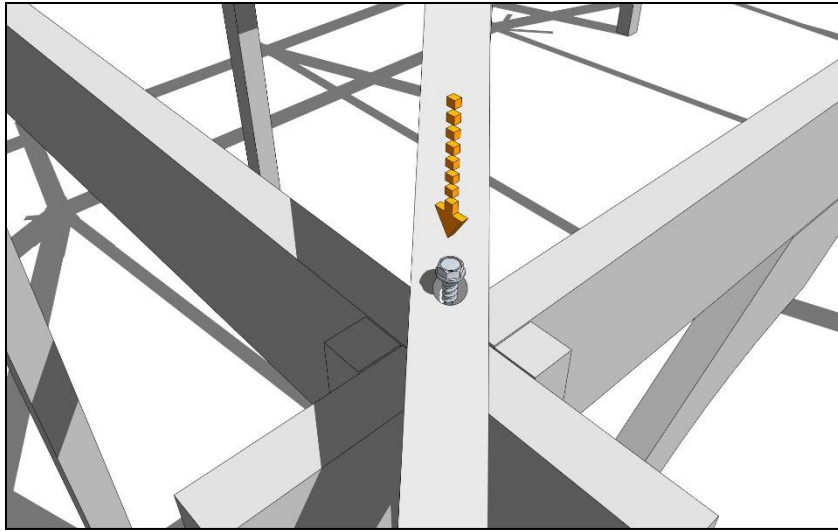

Align the lower end so that it sits centrally on the post top as shown here and fix into place with a 200mm coach-screw driven down into the posts through the pre-drilled hole. Add the remaining hip joists.

## Step 20

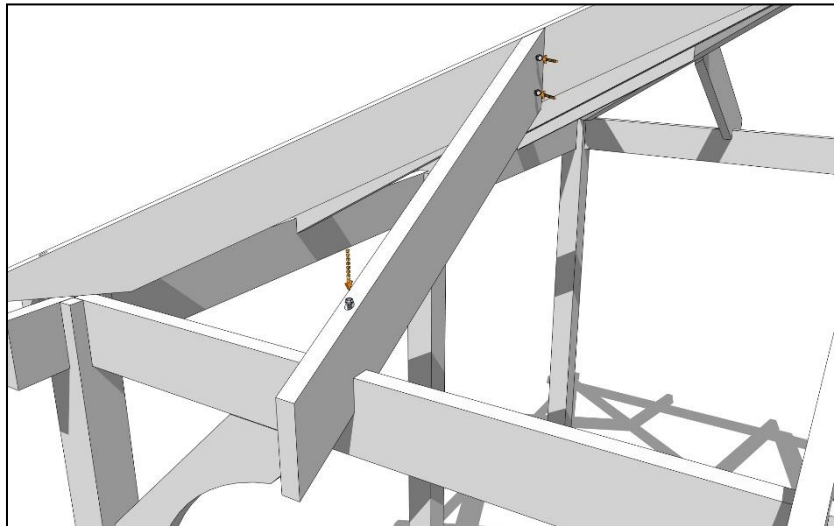

Add a jack rafters to the corner of the structure. Start by ensuring that the top edge butts up against the hip joist correctly, is parallel to the End rafter and then align the lower end notch with the markings on the horizontal runner/rafters. Once correctly aligned, fix the top end in place with 2 x 50mm coach screws driven into the End rafter and the lower end with a 200mm coach-screw down into the rafter/runner. A 4M gazebo will have a short and long jack rafter as shown below.

Rutland County Garden Furniture Ltd, Ashbourne House, 2 Dovecote Meadows,  
Aslackby, Sleaford, Lincs, NG34 0HZ.  
Company No: 11025348 VAT No: 282569762

# THE AYSTON GAZEBO

## Step 21

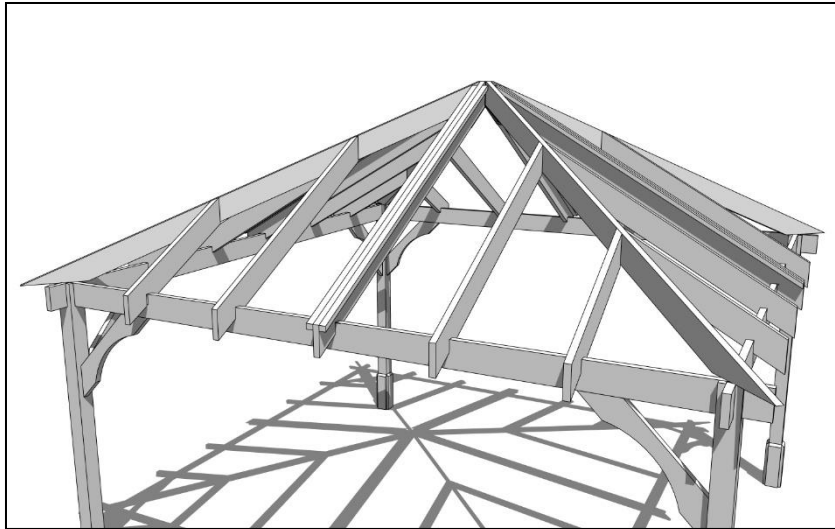

Roof frame completed on a 4M version with long and short jack rafters.

## Step 22

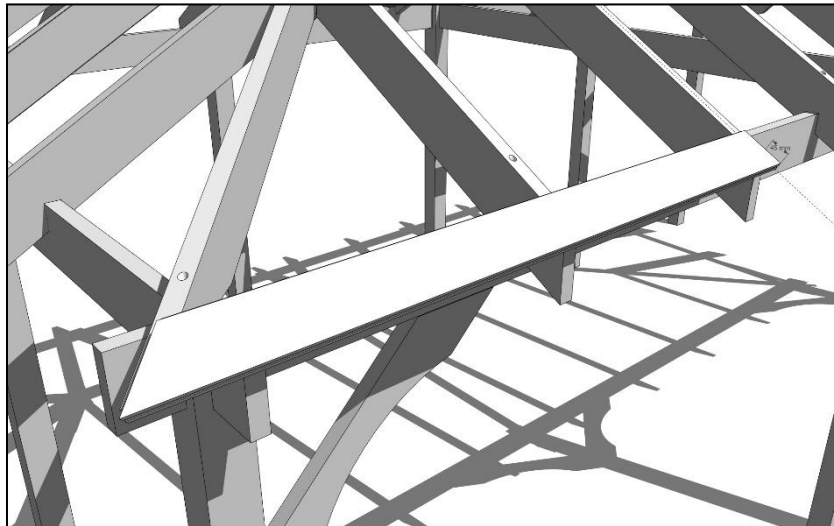

Take one of the longest corner T&G slats and align it with the bottom corner of the structure so that it covers 50% of the hip joist and the other end 50% of the End rafter.

# THE AYSTON GAZEBO

## Step 23

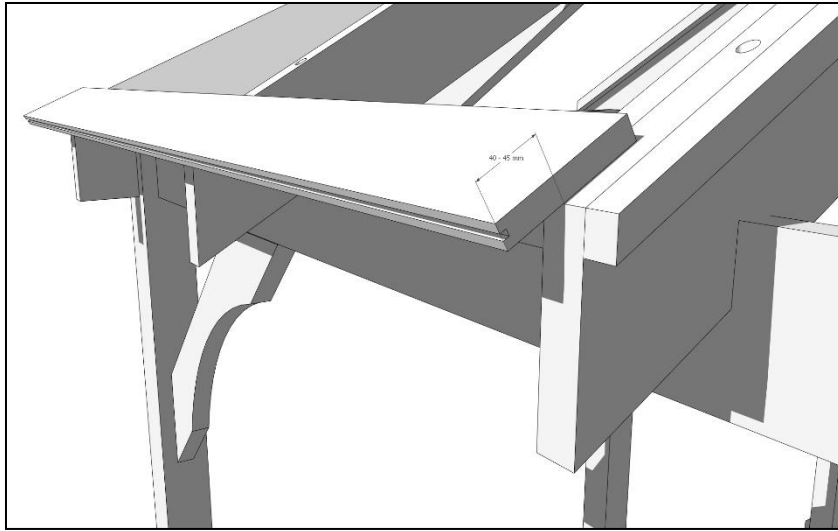

There should be about 40-45mm overhanging the rafter when correctly aligned.

## Step 24

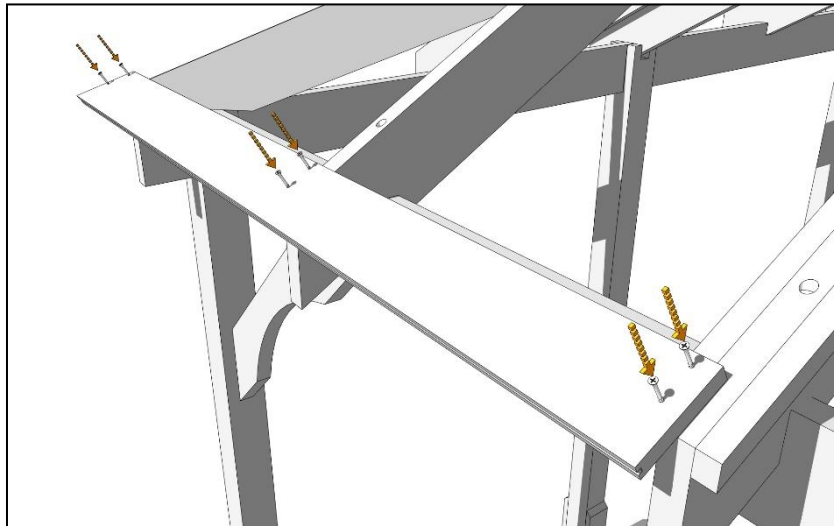

Once you are satisfied the slat is correctly aligned, fix into place with a pair of 40mm screws at each end and through the jack rafter (as you work your way up the roof the screws into the jack rafter will become unnecessary).

# THE AYSTON GAZEBO

## Step 25

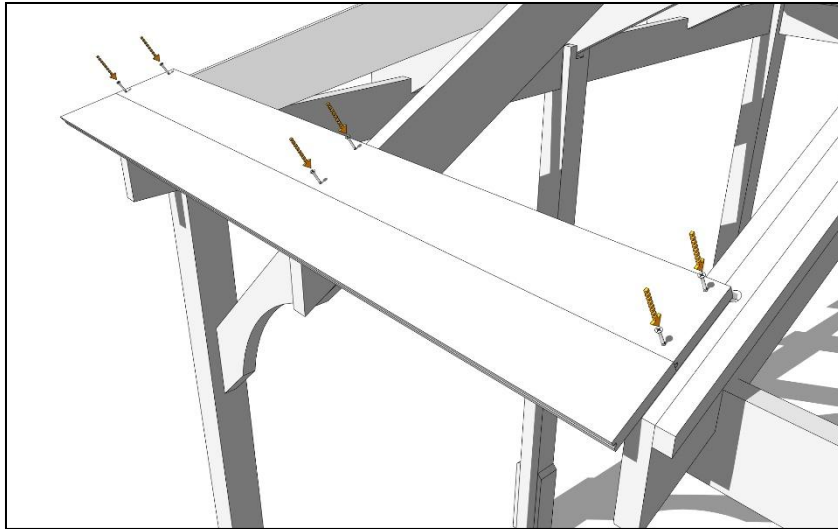

Take the next smallest piece of T&G and slot it into place above the previous piece. Line it up and fix into place as before.

## Step 26

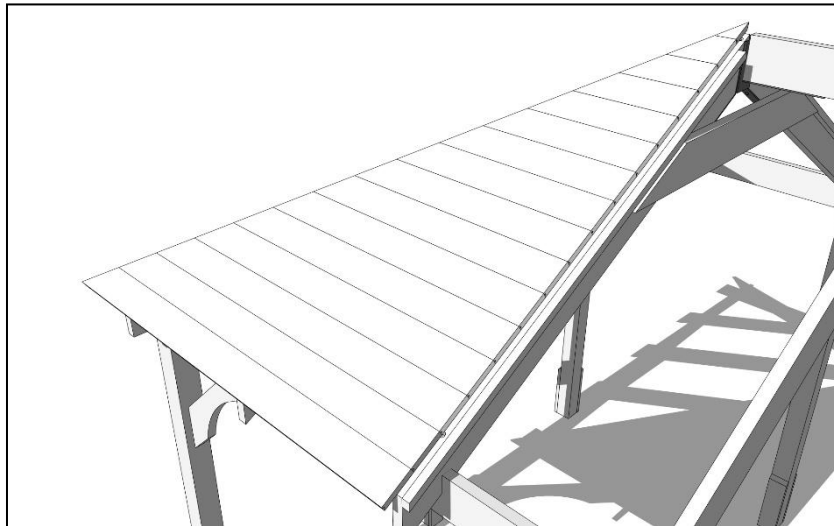

Continue to add progressively smaller slats, working your way up the roof until you have reached the apex.

# THE AYSTON GAZEBO

## Step 27

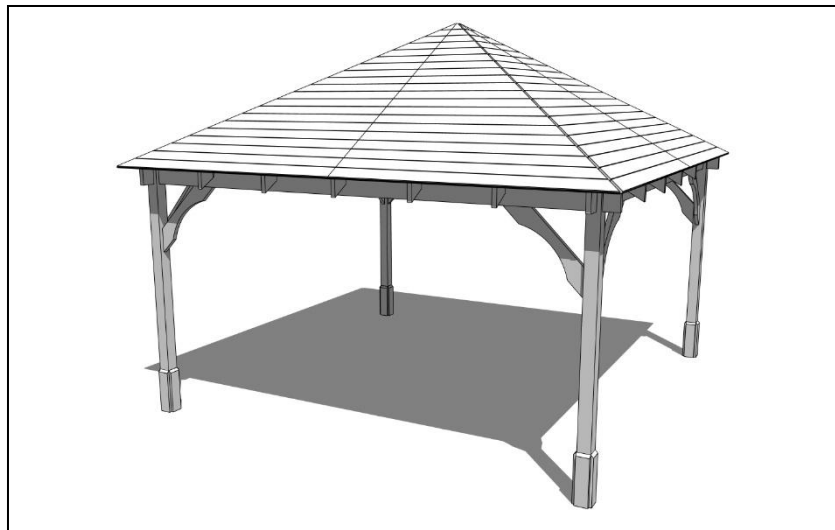

Repeat the previous T&G steps for the remaining corner sections of the roof until each end is totally clad with T&G.

## Step 28

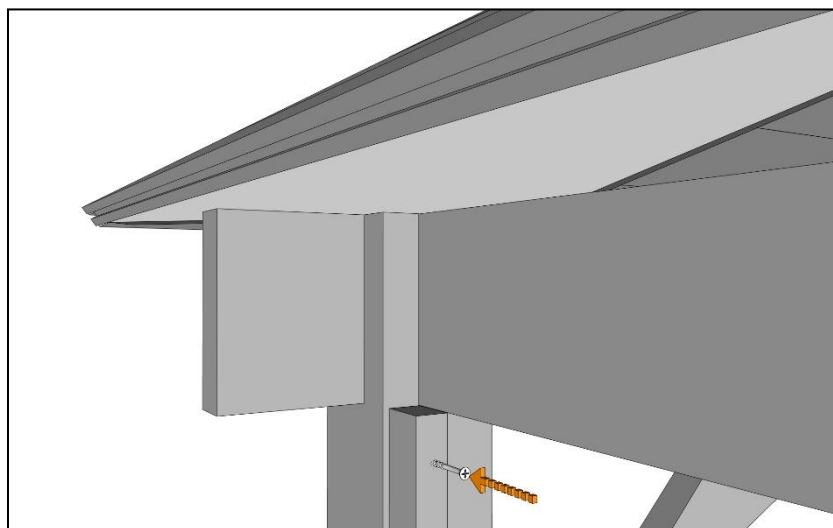

On each of the wall sections prepare the posts for the cladding by adding a piece of batten, its narrower face up against and parallel to the post. The inner face of the batten should flush against the underside of the rafter/runner with about 5mm of post showing at the rear edge.

# THE AYSTON GAZEBO

## Step 29

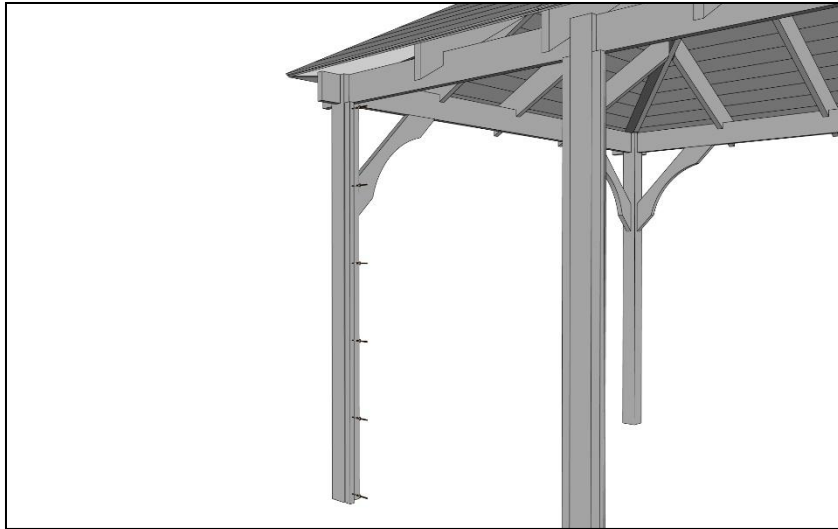

When lined up correctly, screw to the post with a 70mm screw at about 300mm intervals.

## Step 30

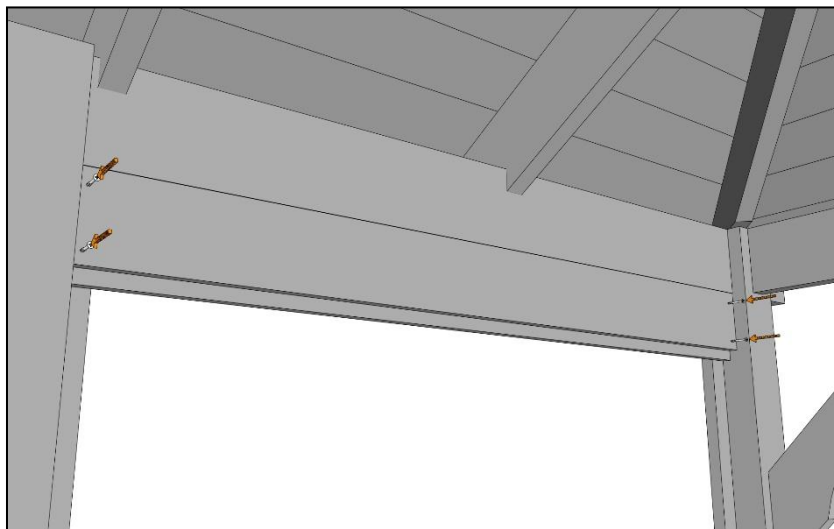

With all of the battens screwed into place, commence adding the wall cladding. Start at the top of the posts and position a bottom/top wall slat (this will only have one edge with a machined rebate) of the correct length and the rebate at the bottom and facing the interior of the gazebo. Butt it up against the battens and up against the underside of the rafter/runner before fixing each end to the battens with a pair of 50mm screws.

# THE AYSTON GAZEBO

## Step 31

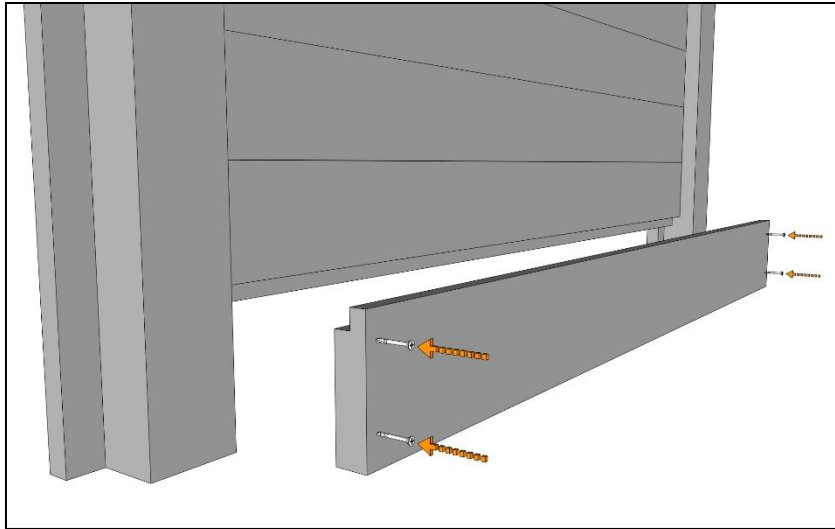

Work down the wall adding slats with a double rebate, aligning the rebates so each one slots into the previous one. Once you reach the bottom of the wall and you can add only one more slat...

## Step 32

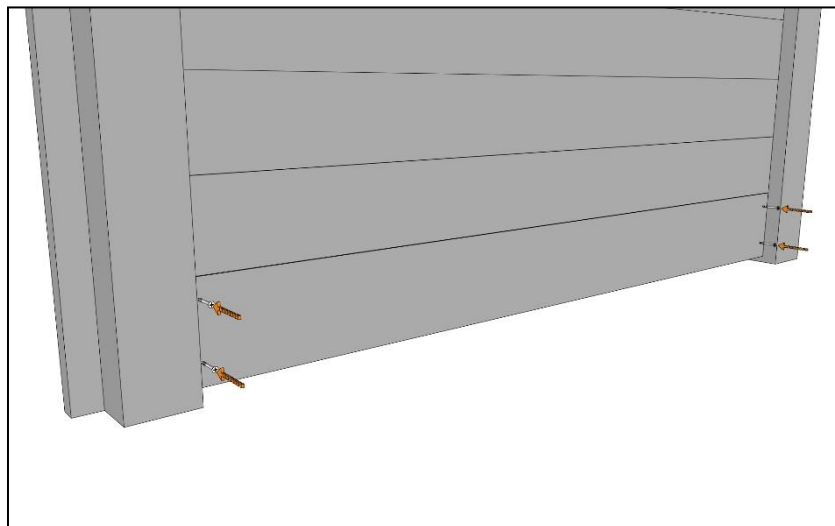

...use a bottom slat with single rebate to finish off the panel as shown here.

# THE AYSTON GAZEBO

## FITTING HANDRAILS (OPTIONAL)

### Step 33

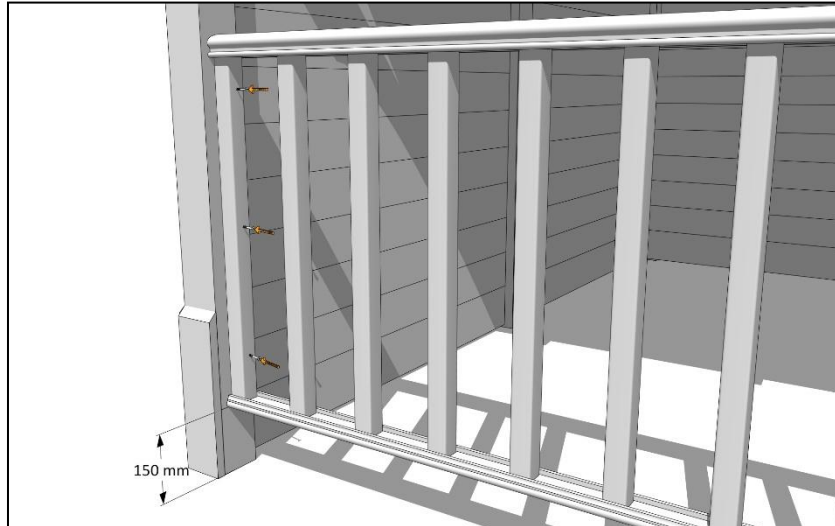

To add a railing section, take the appropriately sized panel and slide it between the posts, the underside around 150mm above ground level (this can also be higher or lower, depending on personal preference) and with the end baluster centred on the post. Now fix in place with 3 x 90mm woodscrews driven into the pre-drilled clearance holes as shown.

### Step 34

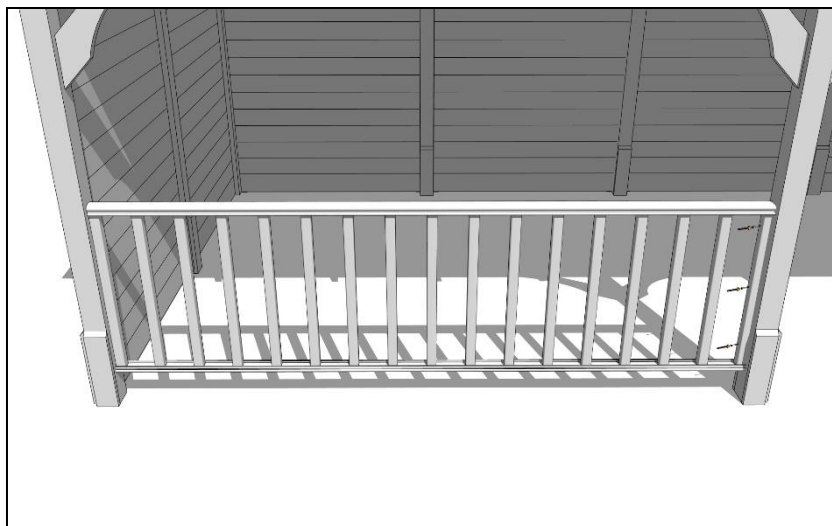

Use a spirit level to ensure the top of the railing is level before fixing the other end of the railing into place in the same fashion.

# THE AYSTON GAZEBO

## Step 35

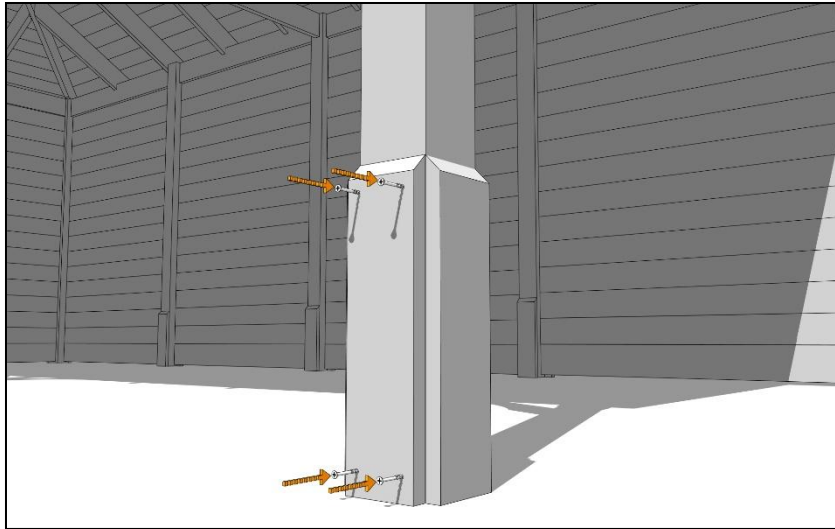

Once all wall panels and railings have been fitted, add pedestal panels to each visible face of the post bottoms. Align each panel against the post bottom and fix each corner in place with a 60mm screw.

## Step 36

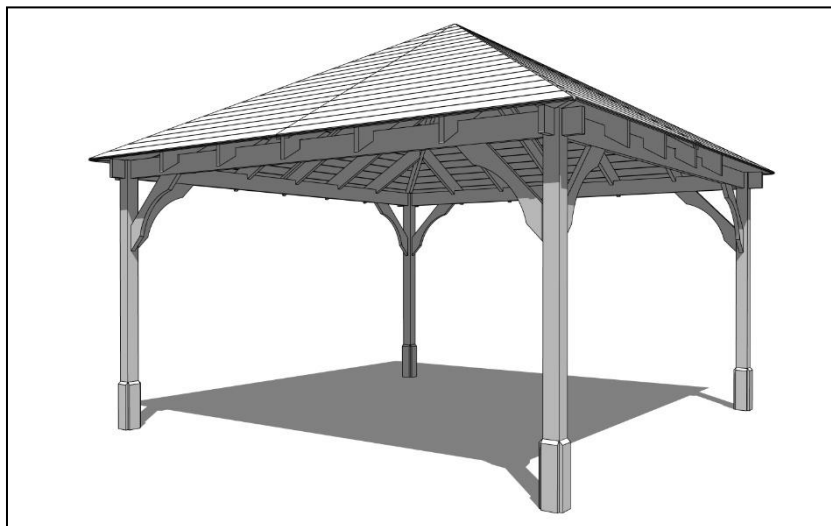

Your gazebo is now ready for the felt roof application.

# ROOF COVERING

## Felt roof application

The following instructions are provided by our felt roof supplier. They provide all the information you need to add your roof felt shingles and the techniques required to finish the ridges.

# Fixing Instructions

## Helpful fixing guidelines

### For standard conditions and roof slopes

#### (15° to 85° pitch):

- Place one fixing nail 25mm from each end and one fixing nail directly above the centre line of each cut-out.
- All fixings should be on a line 25mm above the top of the cut-out. Proper fixing increases the strength and wind resistance of the shingle roof; so do not skimp on fixings. If a fixing will not enter the decking, use another in a nearby location.
- In very severe exposure areas and on steep roofs (60-85° pitch) use 8 nails per shingle, placing one fixing nail 25mm from each end and 2 nails per cut-out, spaced 25mm left and right above each cut-out.
- In severe weather, a small blob of IKOpro High-Performance Felt Lap Adhesive must be applied beneath the corners of each tab and over each nail head, for additional security before the heat of the sun activates the self-seal patches.
- Always leave a 2mm gap between the ends of individual shingles, to allow for minor adjustments in alignment.

### Understand Your Roof Pitch

- Knowing your roof pitch - the angle at which your roof slopes or pitches - enables you to best plan your project and determine the correct layers of underlay membrane to use.
- IKO Roofing Shingles are designed for application on pitched roofs 15° to 85° on non-habitable buildings.
- For non-habitable buildings of all roof pitches, a single layer of IKO Glass Fibre Underlay 20m (Type 3B) should be used as an underlay. This is laid parallel to the eaves with a 75mm side overlap and 100mm end laps. It is fixed using large headed clout nails at 300mm c/c along the lower edge and down all sloping sides.
- If your building is subject to Building Regulations, then please contact IKO Technical Services for further guidance.

## IKO Armourglass Plus Square Butt Roofing Shingles

### Instructions for fitting shingles on garden sheds and similar buildings

#### Step 1

#### Prepare the roof decking on to which you are fixing the shingles

Check that the roof decking of your structure is sound, clean, dry and stable before starting.



#### Step 2

#### Fix the felt underlay

An underlay consisting of rot proof IKO Glass Fibre Underlay 20m (Type 3B) should always be fixed below the shingles.

Starting at the eaves and working up the slope of the roof, unroll the IKO Glass Fibre Underlay parallel to the eaves. The underlay should extend beyond the roof edges and turn down the external edges by 50mm. Tack into position at 300 c/c along the lower edge and down all sloping sides. End laps should be 100mm and the vertical overlap 100mm.





**Step 3**

**Make and fix the shingle strips for sloping verges**

First make the shingle strips for the sloping verges. When using the IKO Armourglass Plus Square Butt Shingles cut off the tabs from a single shingles strip to create the sloping “verge-edging” pieces. You may prefer to cut through the shingle from the back and cut onto a board so as not to damage the knife blade or anything underneath. These “verge-edging” pieces should be applied first and positioned extending 50mm beyond the edge of the roof.

If a barge board is present on a garden building, it should be removed and reinstated when the shingles have been installed.

Gently fold these verge pieces over the roof edge, taking care to warm the material first in cold conditions so it is more pliable, nailing at 50mm centres. At the corners cut the IKO Roofing Shingles to allow an overlap when folded around the corner and nail this in position.

**Step 4**

**Position the eaves shingle strips**

For the eaves sections use a full shingle strip, turned with the tabs facing up the roof. Position these strips overhanging the roof edge by 50mm. Starting at the left hand eaves corner, place the reversed shingle on to the roof extending 50mm beyond both edges (for ease of detailing at the corner, cut away the edge at an angle – as seen in Fig. 1). At the joints between individual shingle strips, use the tabs (that were previously cut to make the “verge edging”) as soaker pieces.

Place the eaves strips in position and gently fold over the roof edge and nail into final position. Ideally nails should be placed 25mm from each end, just below the line of the cut-outs, with three more nails on a horizontal line between the first two immediately below each cut-out. Holding the shingle in position with one hand, gently fold the overhang over the edge of the roof, extending beyond the underside of the decking to form a drip edge. Once folded, nail fix at 50mm centres.

Continue along the eaves of the roof in the same manner, using the tabs previously cut off of the shingles for the sloping verge as soaker pieces between each shingle strip.

You should cut away the corner of the shingle at an angle to prevent a build-up of laps.

Now all your perimeter detailing should be complete verges, corners and eaves.

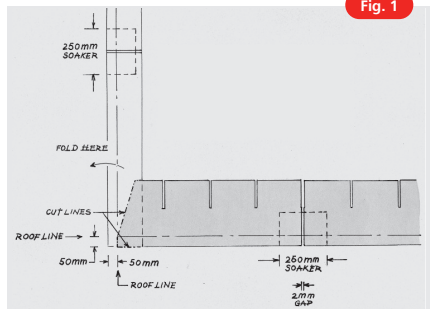

**Fig. 1**

**Step 5**

**Alignment of the first shingle course**

Now set out the position for the first shingle course using either a chalk line or straight edge approximately 5mm from the roof edge.



**Step 6**

**Position and fix the first shingle course**

Trim half, that is 125mm from the verge tab of the first shingle course (row), and continue with full shingles for the rest of the course. Leave a 2mm gap between shingle strips. See Fig. 2. Repeat this for all odd numbered courses.

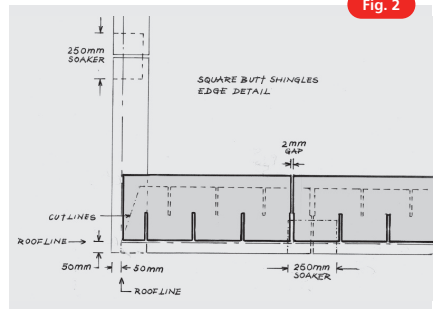

**Fig. 2**

**Step 7**

**Position and fix the higher courses**

Use whole shingle strips for the placing of the second and all further even numbered courses creating a staggered effect as shown in the illustration. See Fig. 3.

For normal fixing, shingles should be nailed 25mm above each cut-out and 25mm in from each edge.

Continue to fix the shingle strips up the roof, creating a staggered effect. The bottom edge should just overlap the top of the cut-outs of the underlying shingles so that there will be approximately 145mm of each shingle exposed.

Roofing adhesives can be used sparingly, covering the nail heads of individual fixing points and in the corner of each tab. This also gives added security in exposed locations.

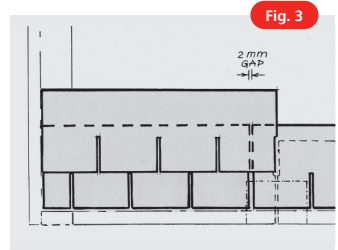

**Fig. 3**

**Step 8**

**Cut IKO Roofing Shingles to create ridge shingles**

To finish the roof we make the ridge capping. For the ridge, IKO Roofing Shingles must be cut from the shingle strips, in line with the cut-outs. See Fig. 4.

Four ridge shingles can be cut from each shingle strip. Shingles can be more readily cut if scored on the back, allowing the shingle to separate away easily. Alternatively you can cut from the front, or mineral side (as shown).

To assist in making the ridge shingles lay flat, make secondary cut lines as shown in the illustration.



**Step 9**

**Alignment of the ridge shingles**

Use a chalk-line or straight edge to ensure the correct positioning of the individual ridge shingles.



**Step 10**

**Position and fixing of ridge shingles**

On the ridge of the roof each ridge shingle should overlap the previous one, as shown, exposing approximately 145mm.



**Step 11**

**Seal the lap joints in the ridge shingles**

A bead of IKOpro High-Performance Felt Lap Adhesive should be used to seal the joint. Bed down onto 25mm strips of IKOpro High-Performance Felt Lap Adhesive to seal the open ends.

**Fig. 5**

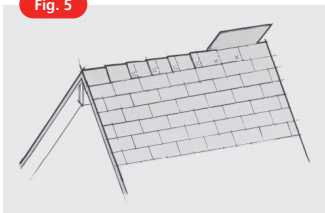

**Step 12**

**Position and fix of the ridge shingles**

Continue to fix the ridge shingles along the roof ridge, bending lengthways down the centre to achieve equal exposure on both sides of the ridge as shown in Fig. 5. In cold weather remember to warm the shingles before folding. Seal the lap and nail fixing on both sides.



**Shingle application in valleys**

Cover the valley with the 1m wide IKO Glass Fibre Underlay 20m (Type 3B). Vertical laps if unavoidable should be a minimum of 300mm and sealed with IKOpro High-Performance Felt Lap Adhesive. Nail at 400mm intervals 25mm from the edge. Then lay the main roof underlay so that it goes over the valley and overlaps the adjacent roof plane by 300mm. Cut this parallel to the valley then seal with IKOpro High-Performance Felt Lap Adhesive. The underlay on the opposite roof plane would similarly overshoot the valley by 300mm and would also be cut parallel and then sealed with IKOpro High-Performance Felt Lap Adhesive. Do not nail within 150mm of the valley centreline. For best performance, start applying shingles on the roof plane with the lower slope or biggest surface. The starter strip must be woven (extend 250mm onto adjoining roof plane). Do not nail within 150mm of the valley centreline. Use one extra nail at the end of each shingle crossing the valley. After completing this roof plane, snap a chalk line 50mm from the centre line on the roof plane still to cover. Apply the shingles onto the second plane, trim shingles to the line and cut a 50mm triangle off the top corner to direct water into the valley. Glue the valley end of each shingle with IKOpro High-Performance Felt Lap Adhesive. Do not nail within 150mm of the valley centreline. Always arrange layers so that water can run unobstructed to the gutter.

**Step 13**

**The Completed Job**

IKO Roofing Shingles provide a long lasting, attractive, decorated waterproofing finish to a wide variety of garden buildings.



# THE AYSTON GAZEBO

## Step 45

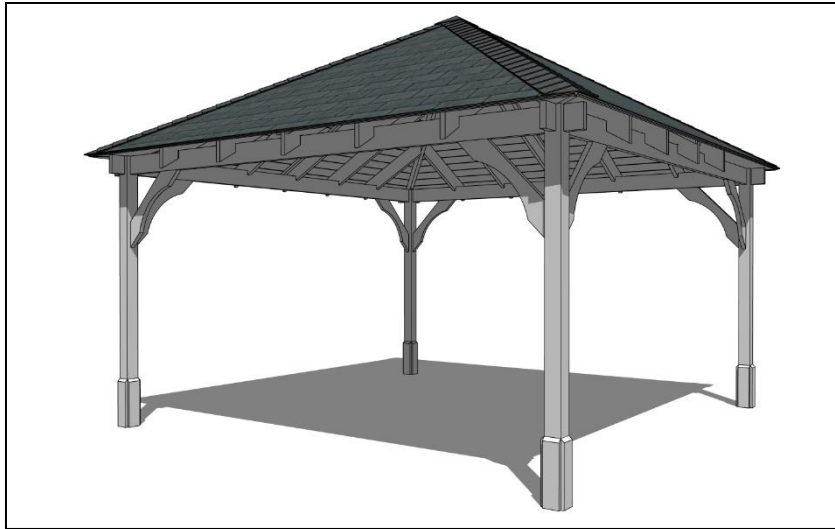

Your Ayston Gazebo is now complete.

WE HOPE THAT YOU FOUND YOUR PRODUCT QUICK AND EASY TO ASSEMBLE BUT IF NOT AND YOU REQUIRE ANY FURTHER ASSISTANCE OR HAVE ANY QUESTIONS YOU CAN CONTACT US BY TELEPHONE ON: 01778 440803

EMAIL: [INFO@RUTLANDCOUNTYGARDENFURNITURE.CO.UK](mailto:INFO@RUTLANDCOUNTYGARDENFURNITURE.CO.UK)

[WWW.RUTLANDCOUNTYGARDENFURNITURE.CO.UK](http://WWW.RUTLANDCOUNTYGARDENFURNITURE.CO.UK)

Rutland County Garden Furniture Ltd, Ashbourne House, 2 Dovecote Meadows,  
Aslackby, Sleaford, Lincs, NG34 0HZ.  
Company No: 11025348 VAT No: 282569762